

Tiles

1. Stable floor tile manufactured
104, by Bloughton Brick Co. 9" x 4 1/2" x 3"
x

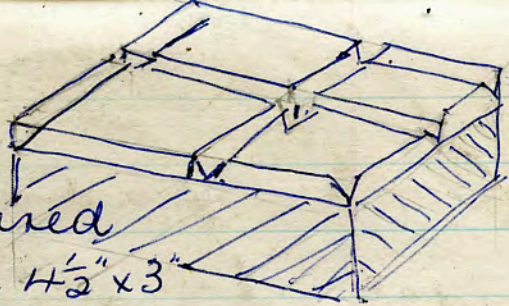

2. Floor paving tile - blue -
105, ex Rwy Passenger Station
x 12" x 6" x 2 1/2"

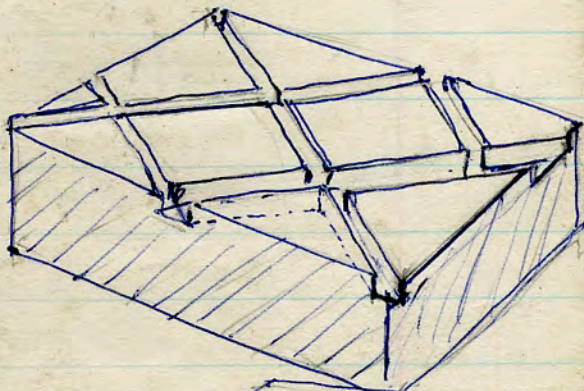

3. Floor tile for grain drying
106, ex Dam Side Windmill
x Pilling. 12" x 12" x 2" 13 1/2 lbs.
Stanley Bros. Ltd. Mureation Patent

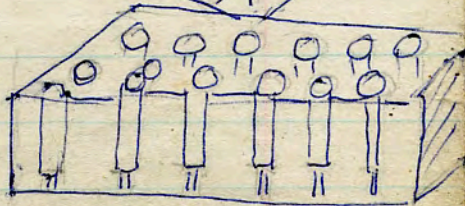

4. Hollow partitioning brick
107, exterior - dovetail grooves to
x retain plaster. 12" x 8 1/2" x 3"

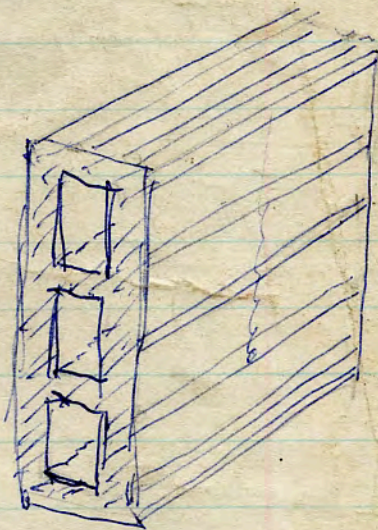

5. Garden edging tile 4" x 1" x 4" 4 lbs.
108, plain / side. scalloped to soil side.

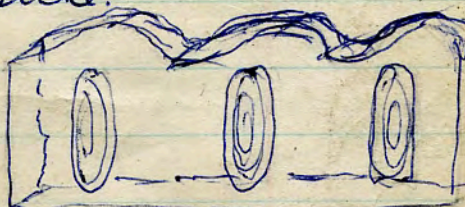

6. Electric cable warning cover
109, 9" x 6" x 1 1/2"
BALDWIN. DANGER ELECTRICITY

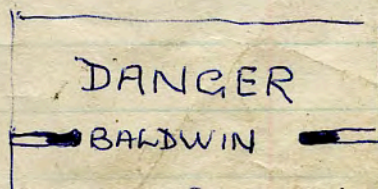

✓ NORI
x110, 7
x

Serrated faced floor tile
see Richard Ashworth

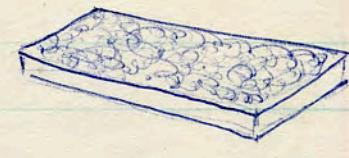

x111

8. Boiler seating. A. B.
letters in relief in stamped panel
small 2" x 1 1/2", very shallow, one side
only. (Brandwood Moor Quarries)
(Abel Brierley?).

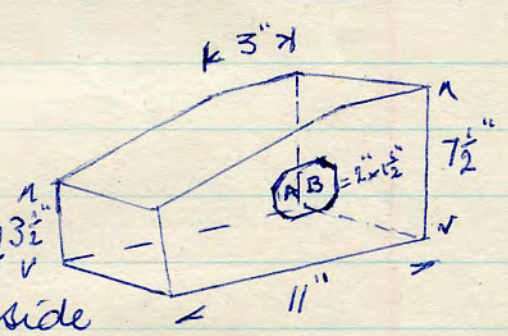

x112
x

9. Window sill in terra cotta.
Decorative.
J. W. TOMWINSON
TERRA COTTA WORKS
SUMMERSEAT.

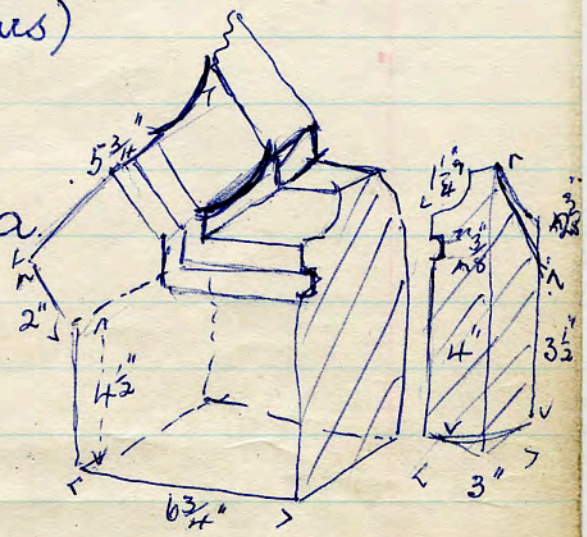

✓ 10.
124
x

barboy stopper (for acid)

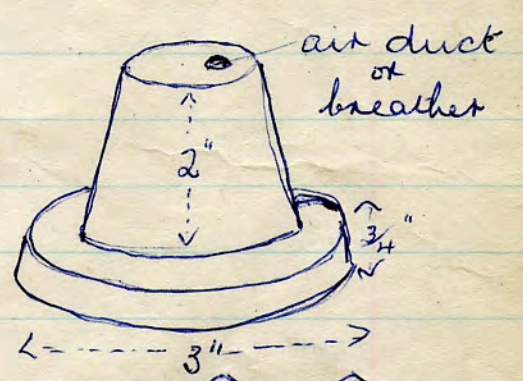

84
x

Decorative tile, use unknown
brown glaze overall.
10 1/2" from point to circle x 8 1/2" wide
leaf pattern & circles, raised 7 lb

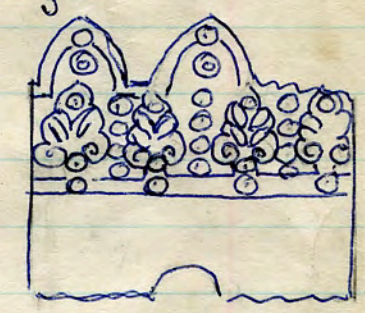

147
x

Decorative garden edging tile
9" x 7 1/2" x 1" black unglazed
indented both sides. 4 1/2 lb

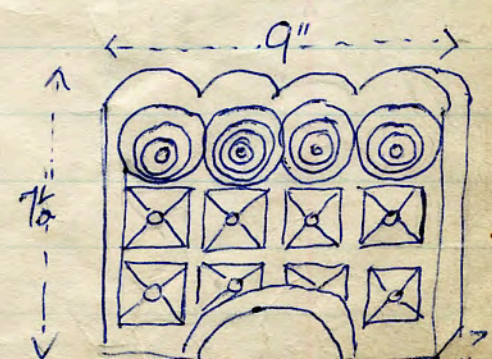

✓ ^{Huncoat} Decorative bricks, needed each side ^{April 1976.}
 x188 (Huncoat) 4 lbs.

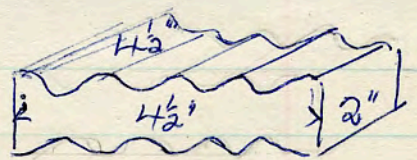

✓ Ornamental bricks, circular
 x189 1" thick 4 1/2" long. (Huncoat) 4 lbs.

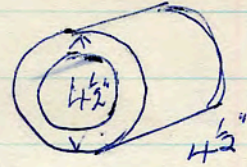

✓ Scotia moulded plinth 5 1/2" x 4 1/2"
 x207 1/2" mould. perforation for fixing.
 (Huncoat)

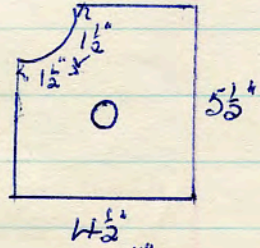

✓ 208 Plinth. 7 1/4 x 4 1/2 x 3"

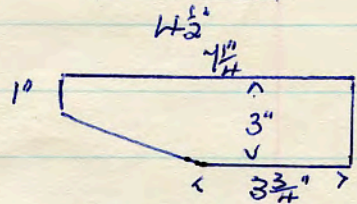

✓ LV ELECTRICITY RD NO 804561
 x209 cable cover

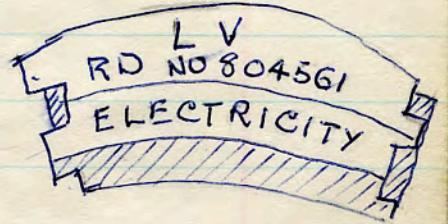

✓ 210 ELECTRIC CABLES RD NO 804561

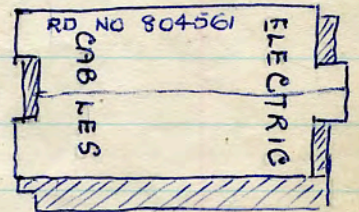

✓ 211 Decorative brick AT
 diamond shape 7 1/2" x 5" x 2 1/2"

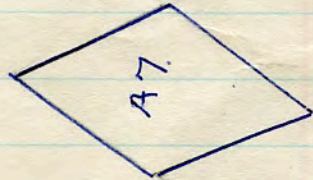

✓ 212 Double bull nosed plinth
 9" x 4 1/2" x 2" 8 in end.

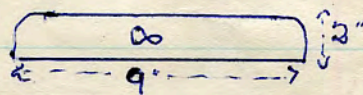

✓ 213 Single bull nosed plinth
 9" x 4 1/2" x 2"

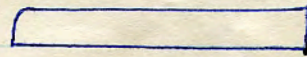

✓ 214 Single rebate brick 13

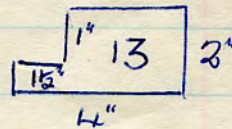

✓ 215 Tile, keyed one face 9" x 2 1/2" x 1 1/4"

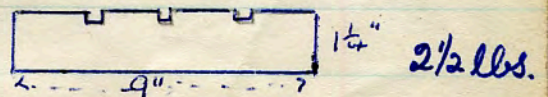

✓ 217 Two semi circular tiles to make
 9" diam. with 3" square hole in

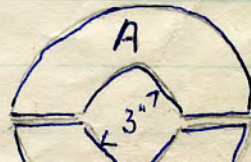

216.
x

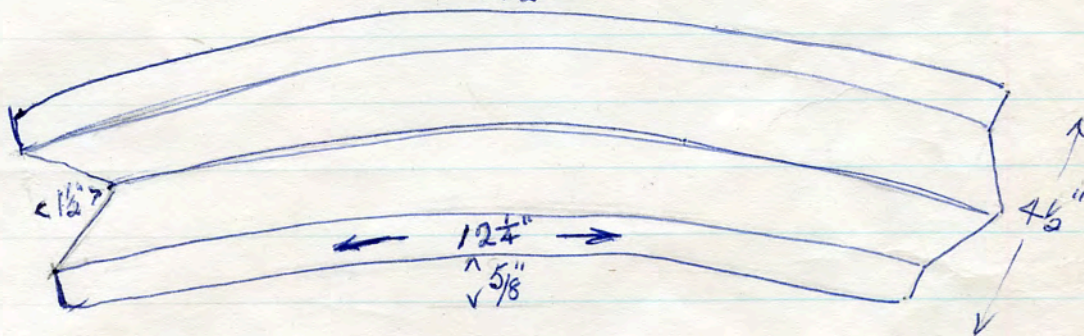
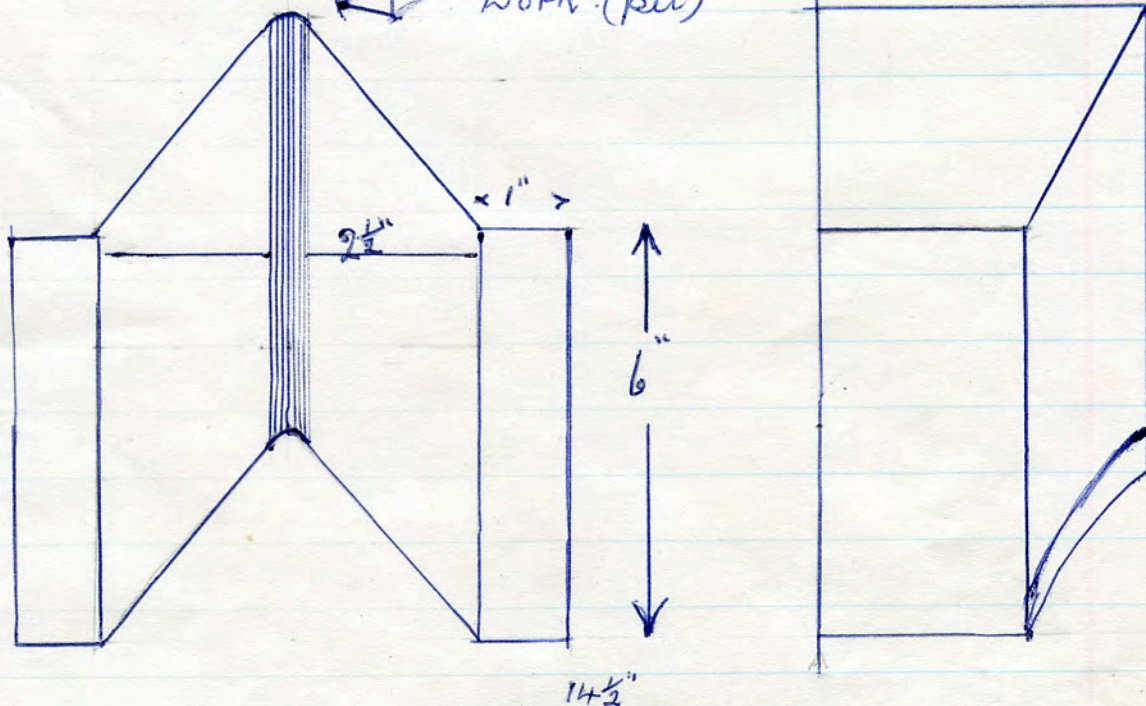
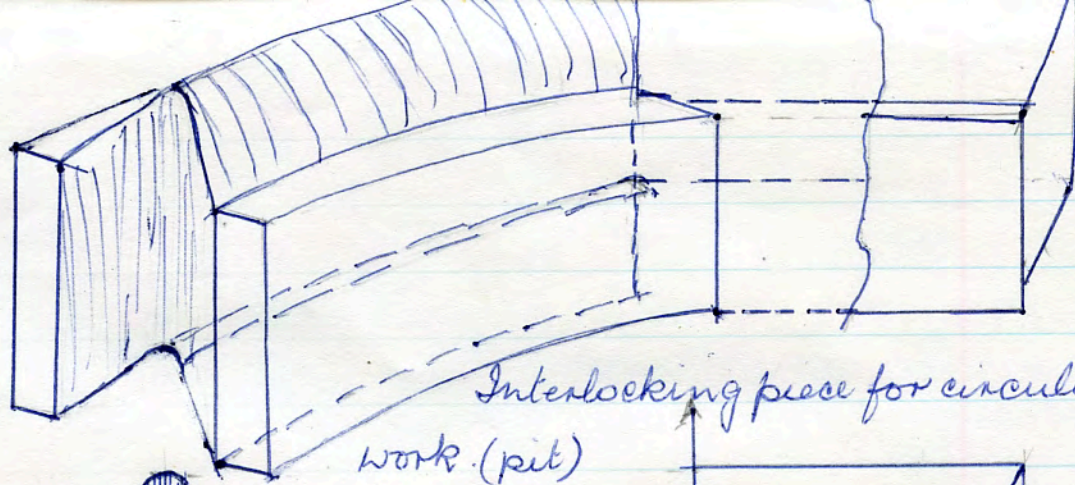

218.
x

tapping tile - 9" x 9" x 4 1/4".

Returned nosed-end piece.

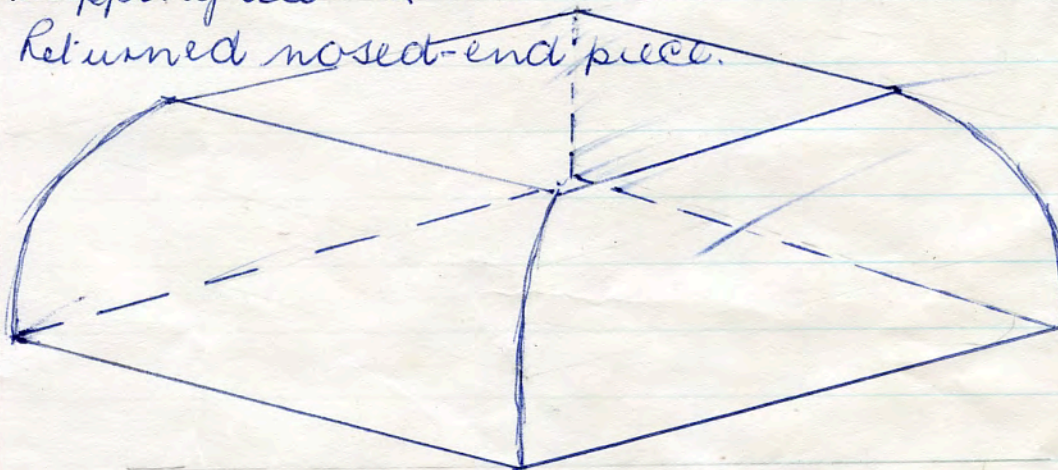

Huncoat 1976. April 19th:

219 x

Ventilation bricks 9" x 6" x 2 3/4"
5 1/2 lbs.

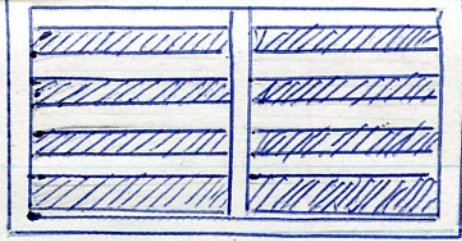

232 x

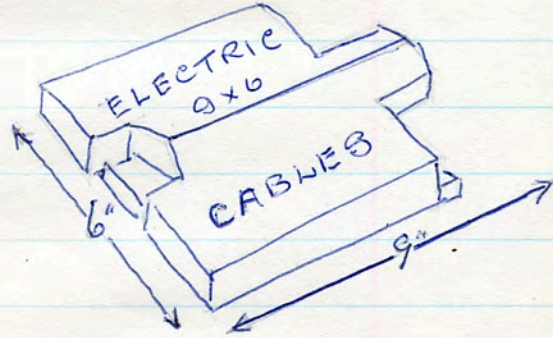

233 x

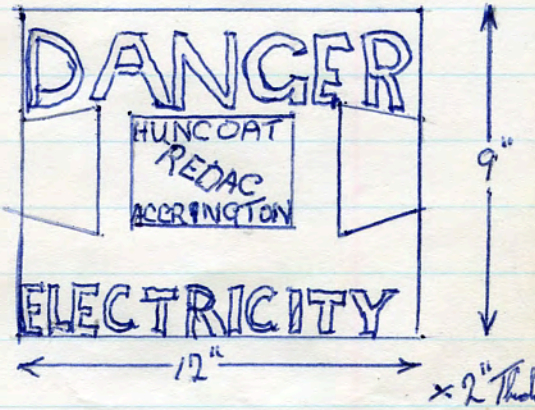

234 x

8 lb Clay

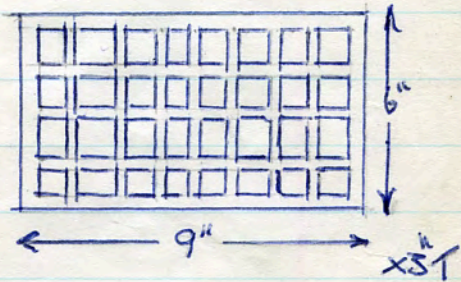

235 x

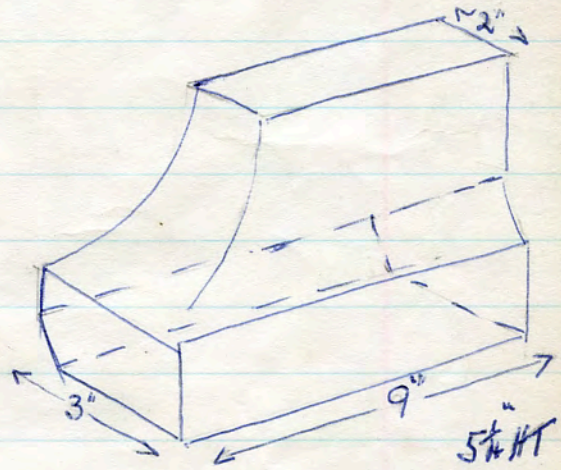

236 x

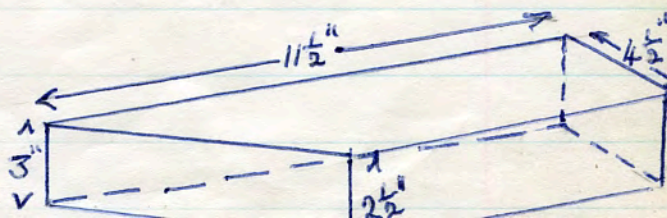

All Huncoat 19. 4. '76

stop end for surface channel

237 x

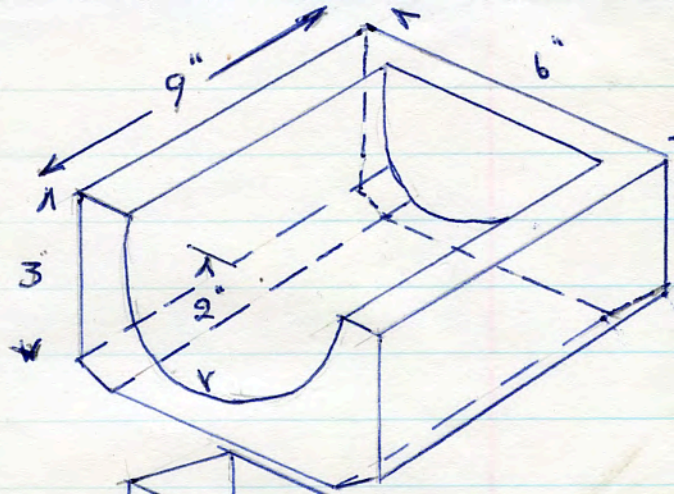

ogee des. mould

238 x

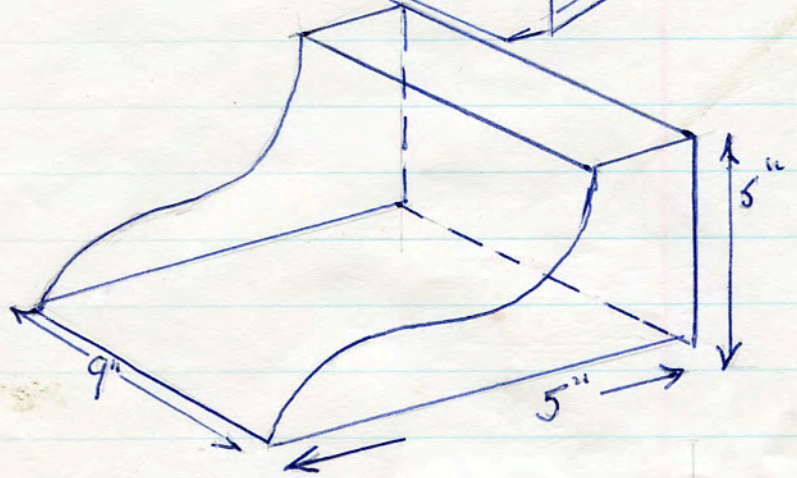

sill piece

239 x

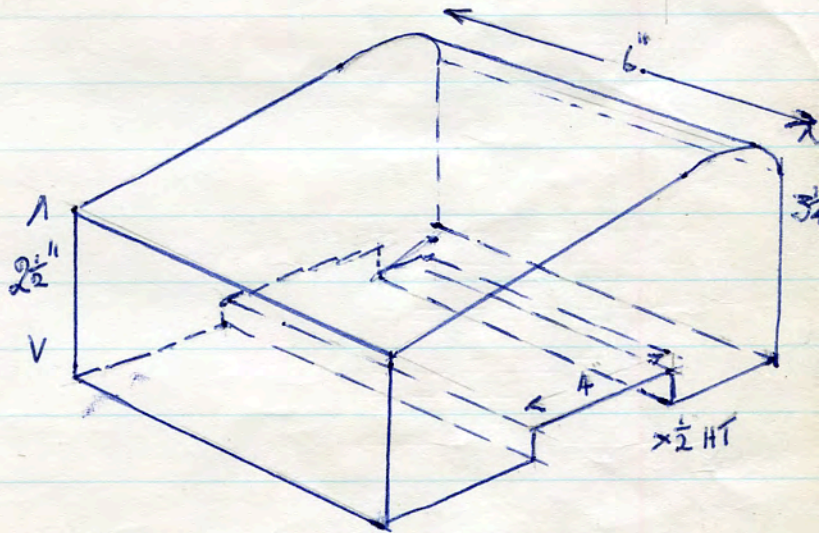

Kiln stand

240 x

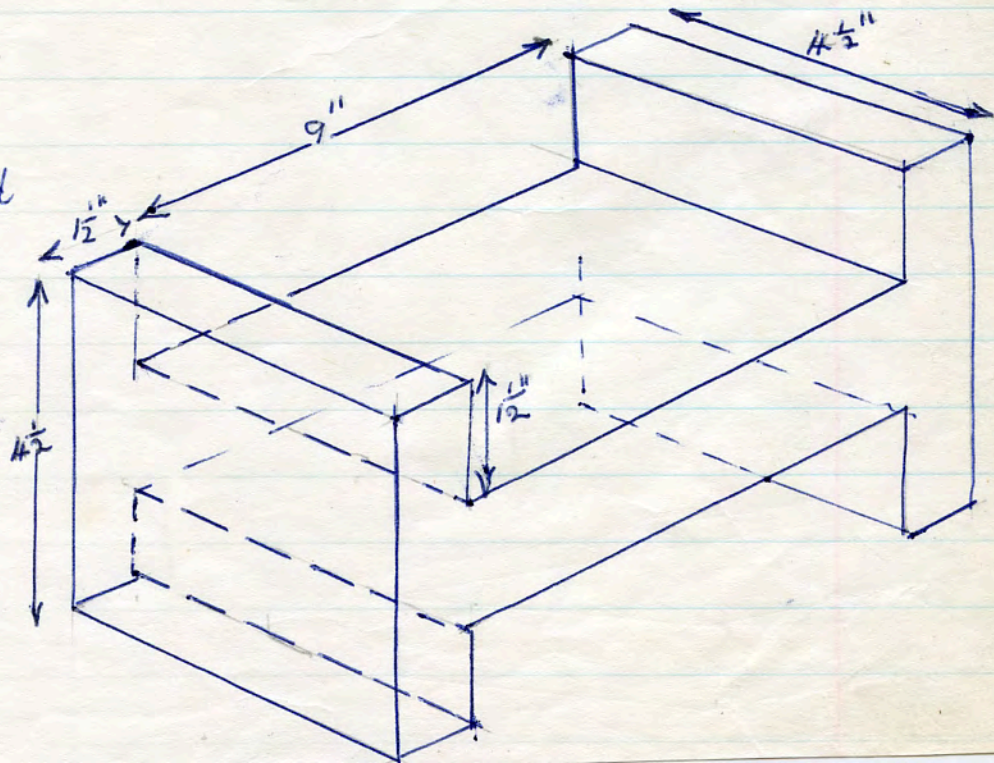

244 x ✓ Garden edge tile - (rope design)
 Bury 9" x 6½" x 1⅝" 7 lbs



245 x ✓ Funcoat capping piece.

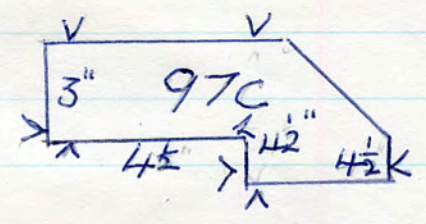

246 x ✓ Stop end of Scotia mould.
 9 lbs.

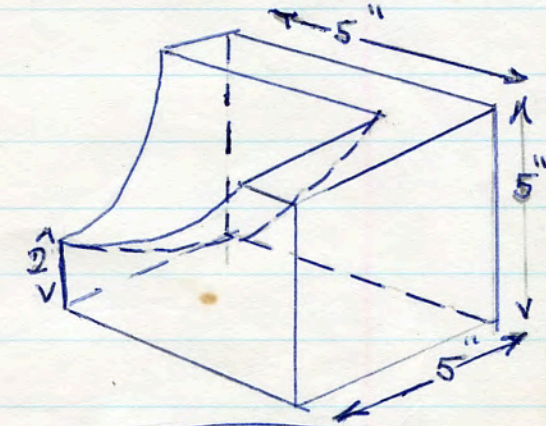

247 x ✓ 1½" x 9" x 2"
 stamped on end 50
 Decorative tile.

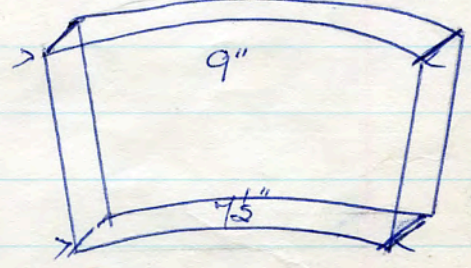

248 x ✓ Decorative dado or
 plinth brick 7 lbs

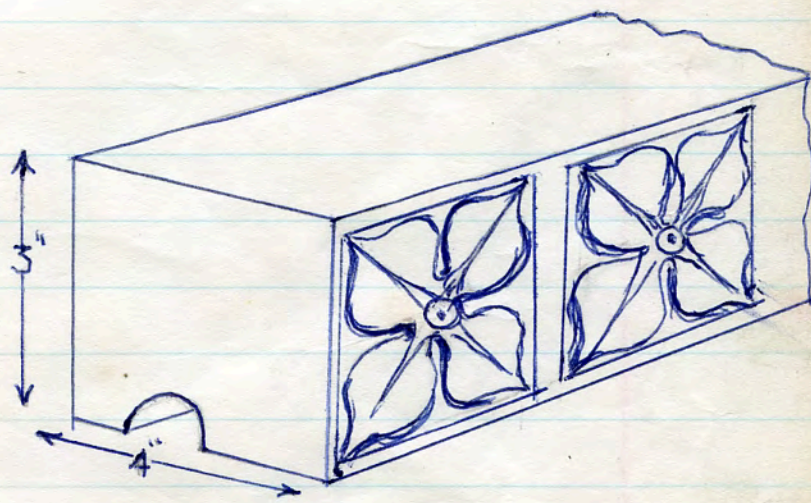

All Funcoat. 19. 4. '76

249 x ✓

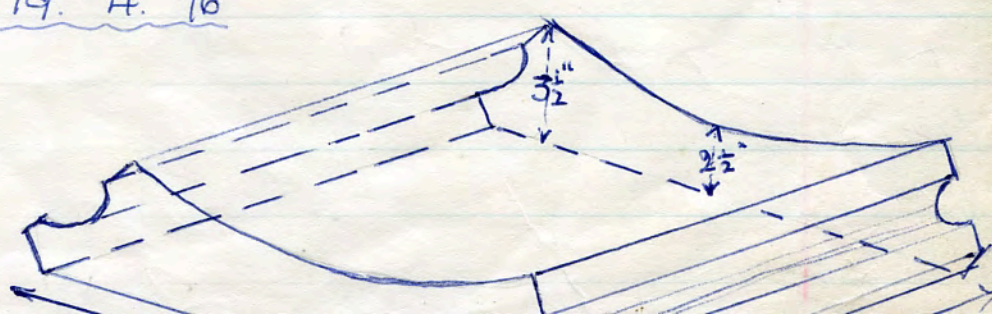

Square tile 6" x 6" x 1 1/2"

257
x

HUNCOAT PLASTIC ACCRINGTON reverse
in small panel - ridged for key.
face side - plain

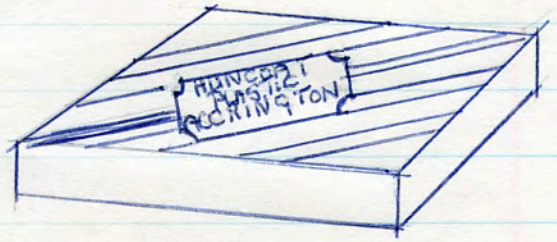

Concise tile

264 x 9" x 6" x 3"

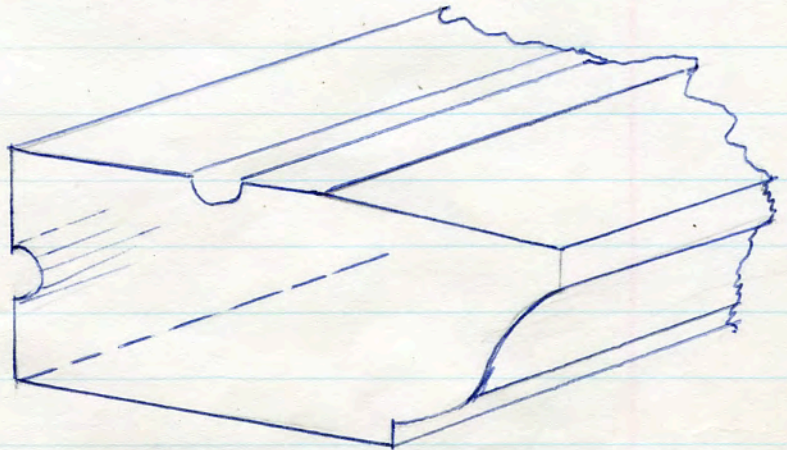

265
x

Tile dish 9 holes (grate). 3/4 Dia
9" x 9" x 3" 14 lbs
(Hoddlesden) Fine Clay
H. 5. 76.

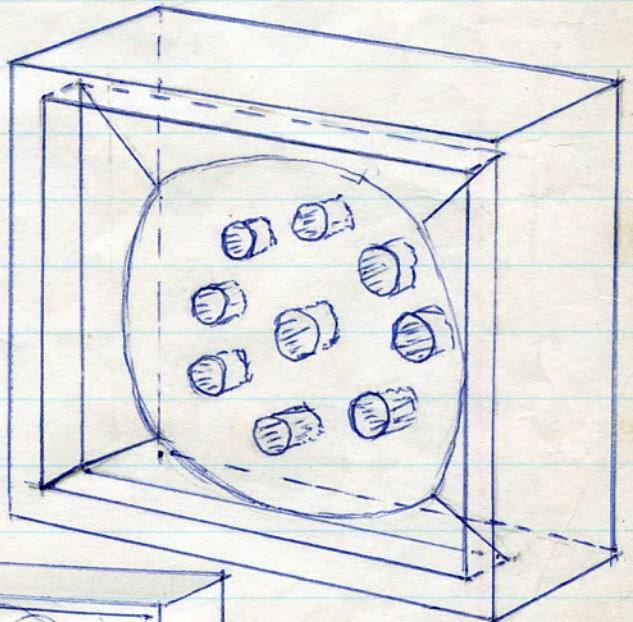

12" x 12" dish for
6" grate.

315 x

H. 5. 76.

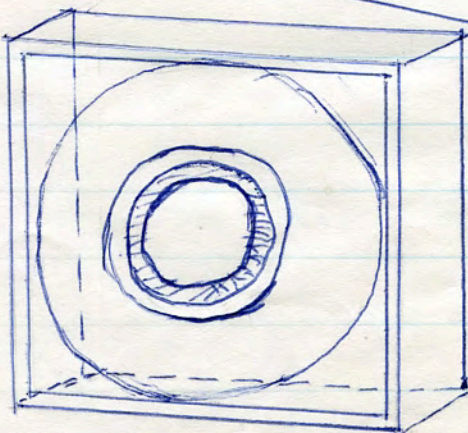

✓
 352 x 9" x 3" x 3" Air Vents
 (Rayton)
 22. 5. '46

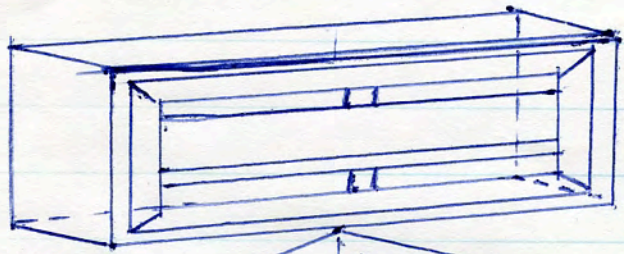

3 1/2 lbs

✓
 333 x Wall Air Vent
 (Rayton)
 22. 5. '46

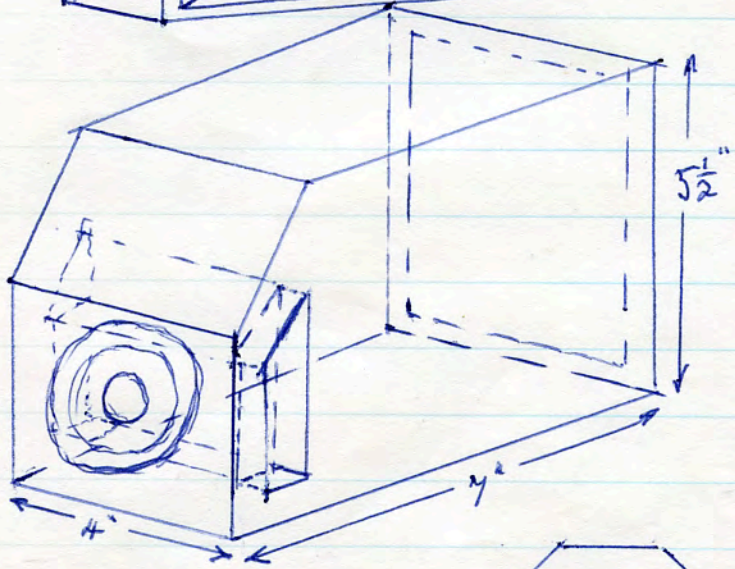

5 1/2 lbs

✓
 363 x Octagonal tile 3/4" thick
 6" across each side 2 1/2" 2 lb

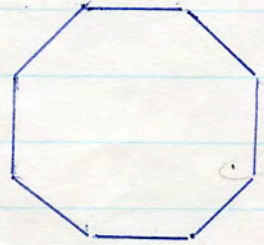

✓
 Diamond String Course Brick 97 A by Scribe Walker
 8 lbs

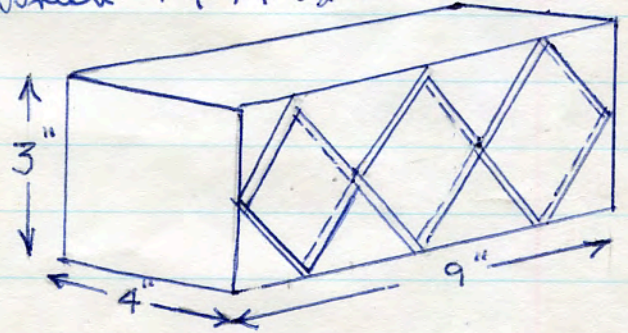

✓
 String Course Brick Red

5 1/2 lbs

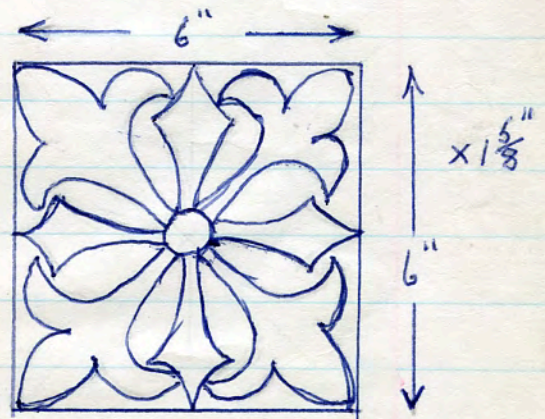

✓
 340 x

All Gorton 26. 6. '76 & 27. 6. '76.

397 x
x

(Gorton) 9 lbs.
 $8\frac{7}{8} \times 14\frac{1}{2} \times 3$



nail head.

Diamond Stretch Brick

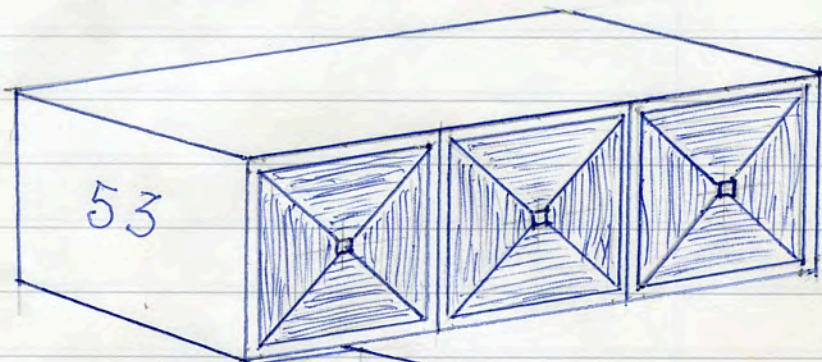
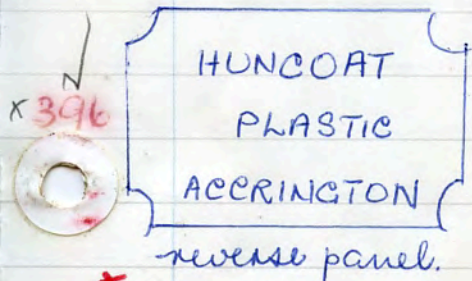

borbel. dec
stretcher

9 lbs.

398 x
x

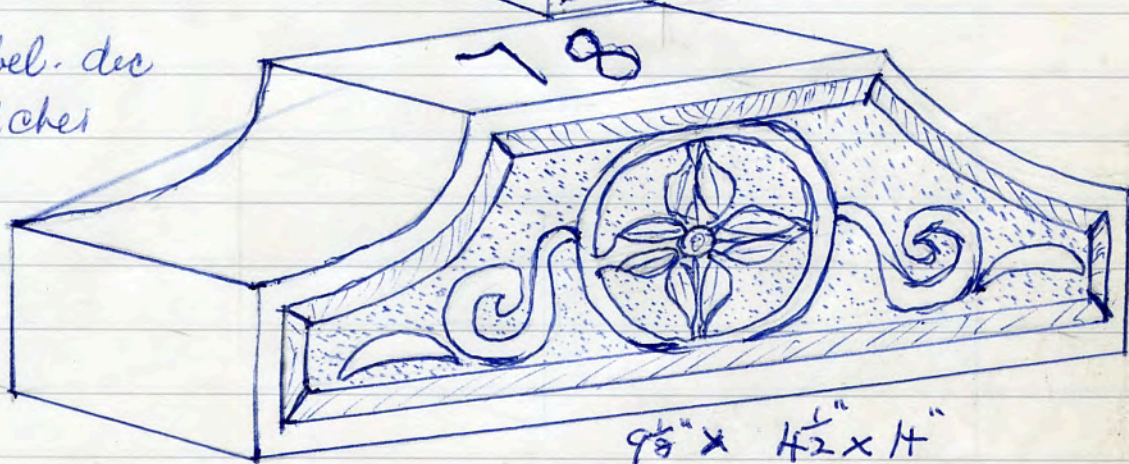

borbel. dec
stretcher
Clay

395 x
x

10 lbs. $9 \times 14\frac{3}{8} \times 4\frac{1}{4}$

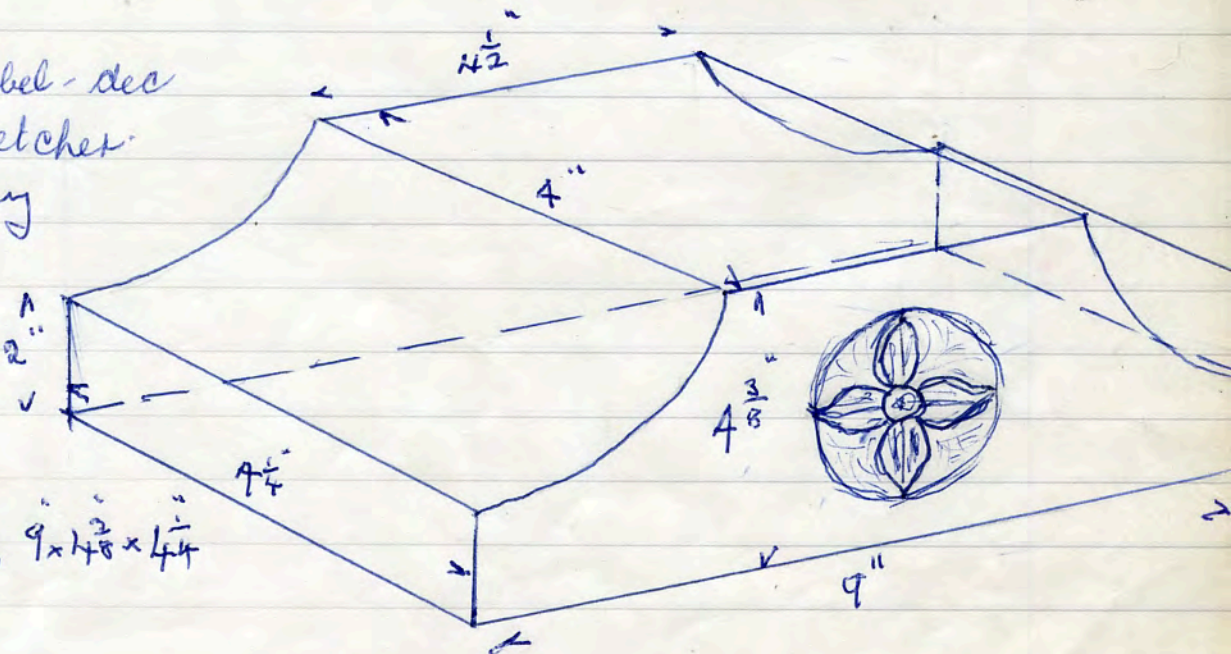

167H

399x

(Newton Heath)
July '76

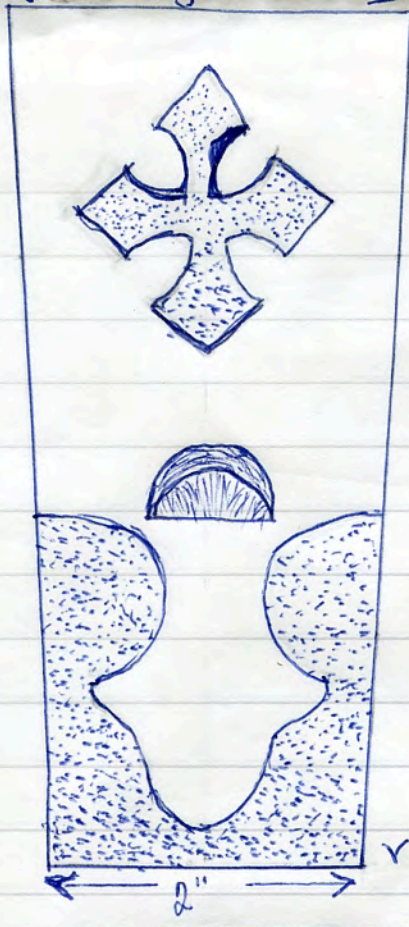

9"
4 1/2" Back to front.
7 lbs.

4 1/2" from face to back

400x

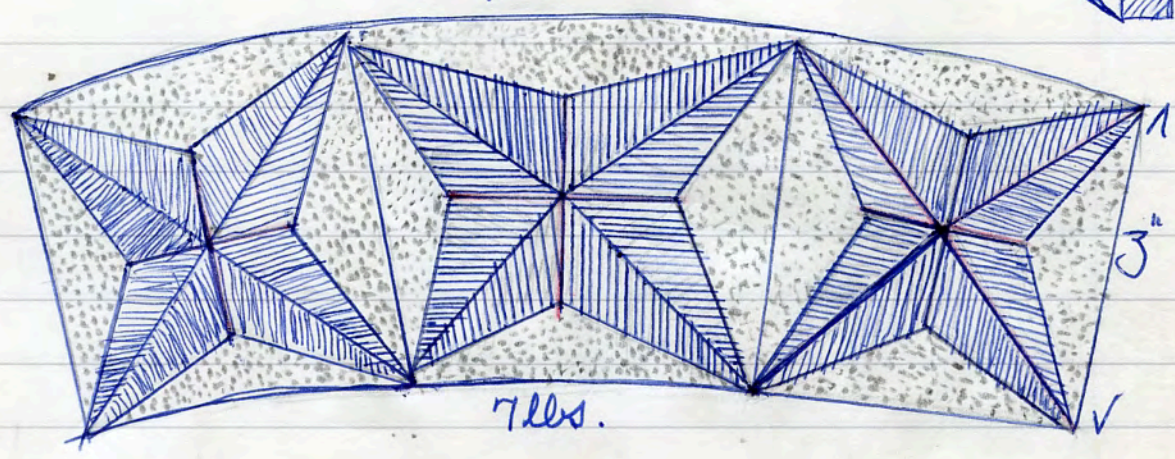

Corbel 9" x 4 1/2" x 3"

401x

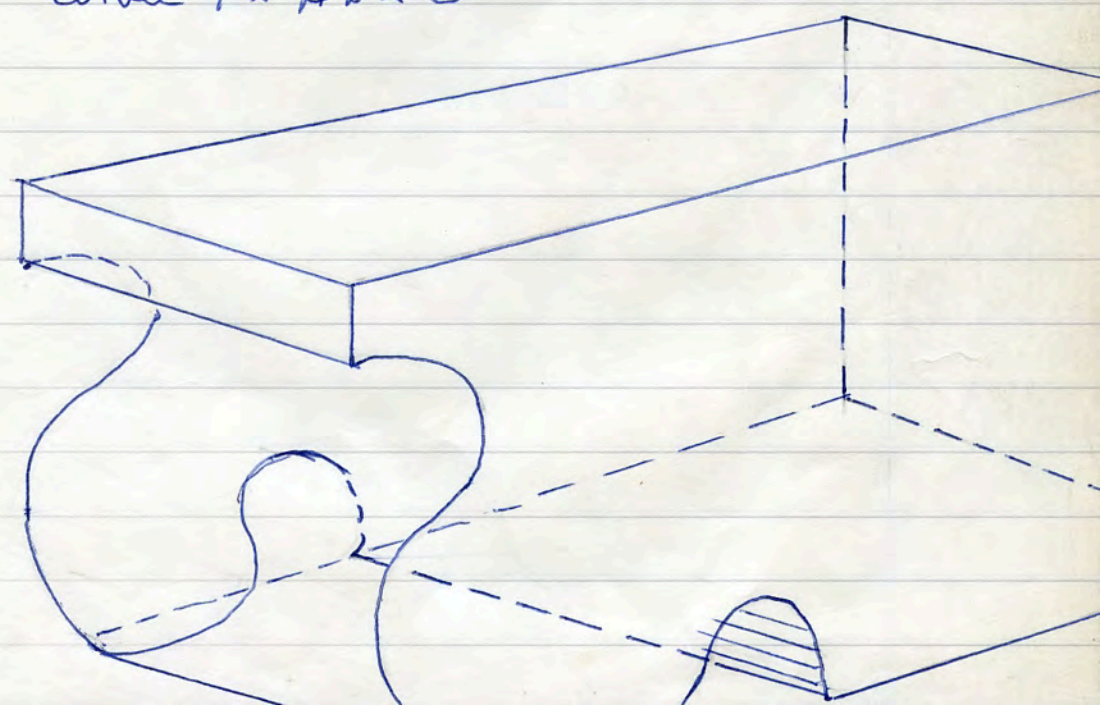

(Newton
Heath)
July '76

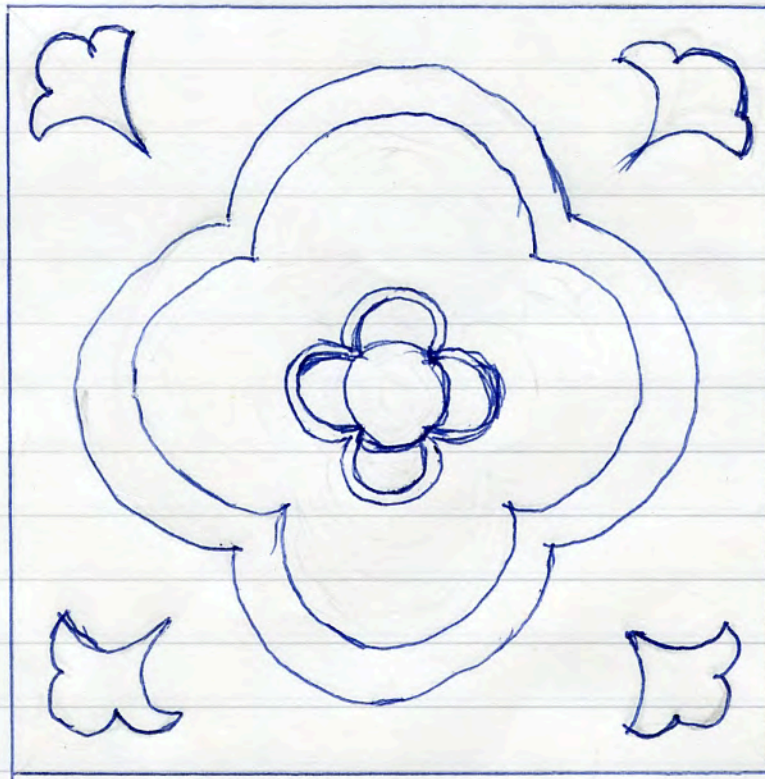

7 lbs Clay

Dado mould or
string course
brick

6" x 6" x 3"

✓
H02
x

G. TRAUNTER stamped reverse.

String course Brick 8 lbs

$8\frac{5}{8}$ "

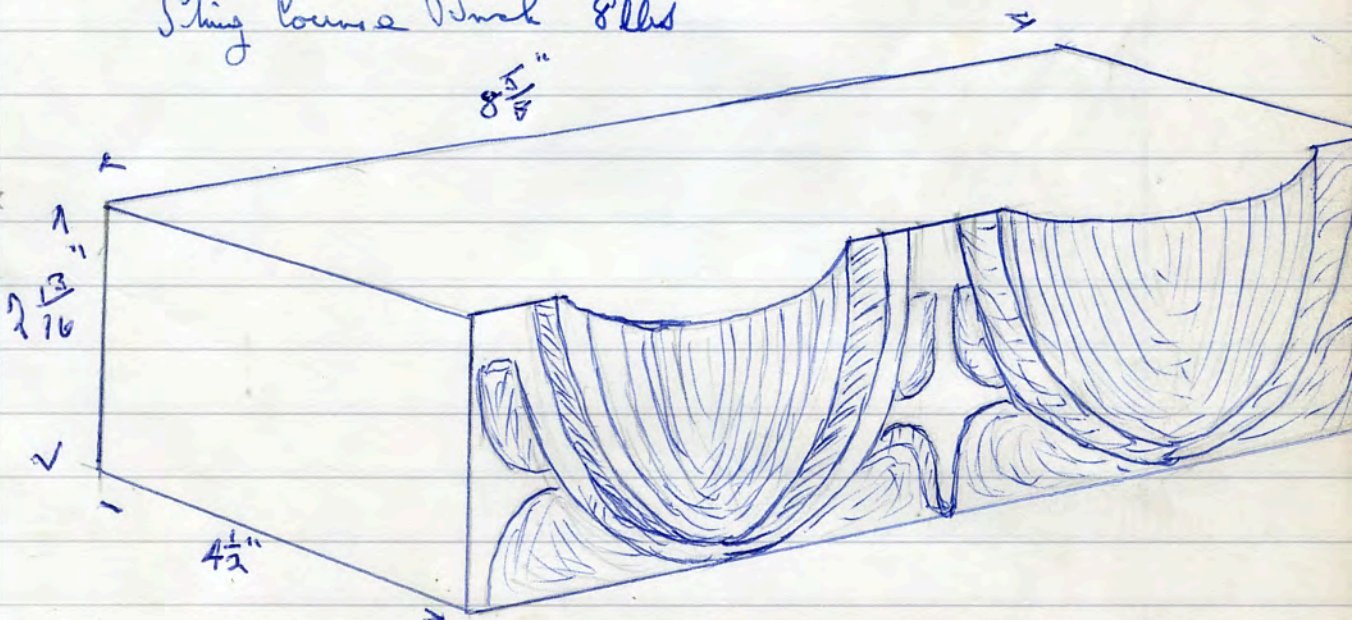

✓
H04 x
x

$1\frac{13}{16}$ "

$4\frac{1}{2}$ "

8 lbs.
Decorative floor tile.

July '76

10" x $4\frac{3}{4}$ " x 2"
5"

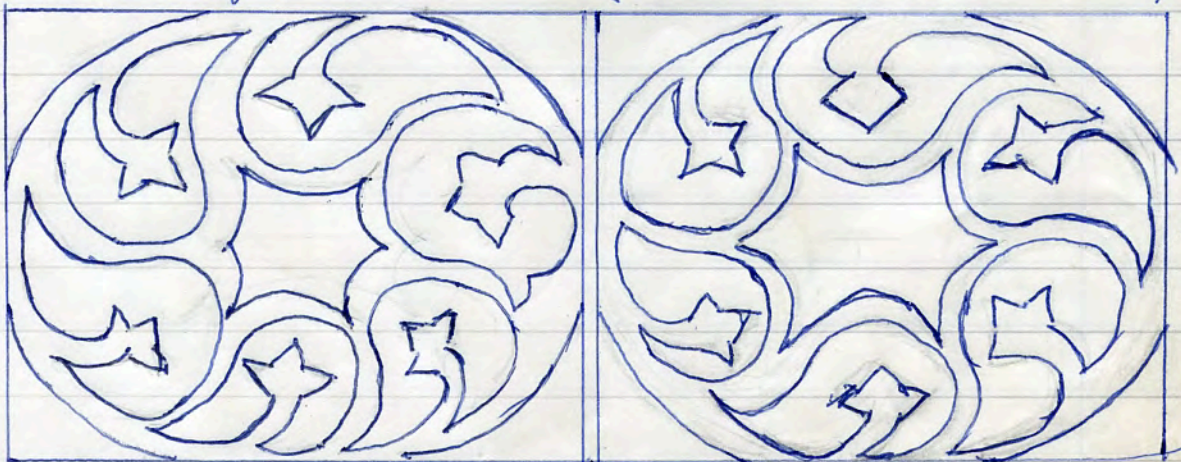

✓
392 x
x

$4\frac{3}{4}$ "

(Newtown Heath) July '76 $6\frac{1}{8}$ "
 $7\frac{1}{2}$ lbs

403
+

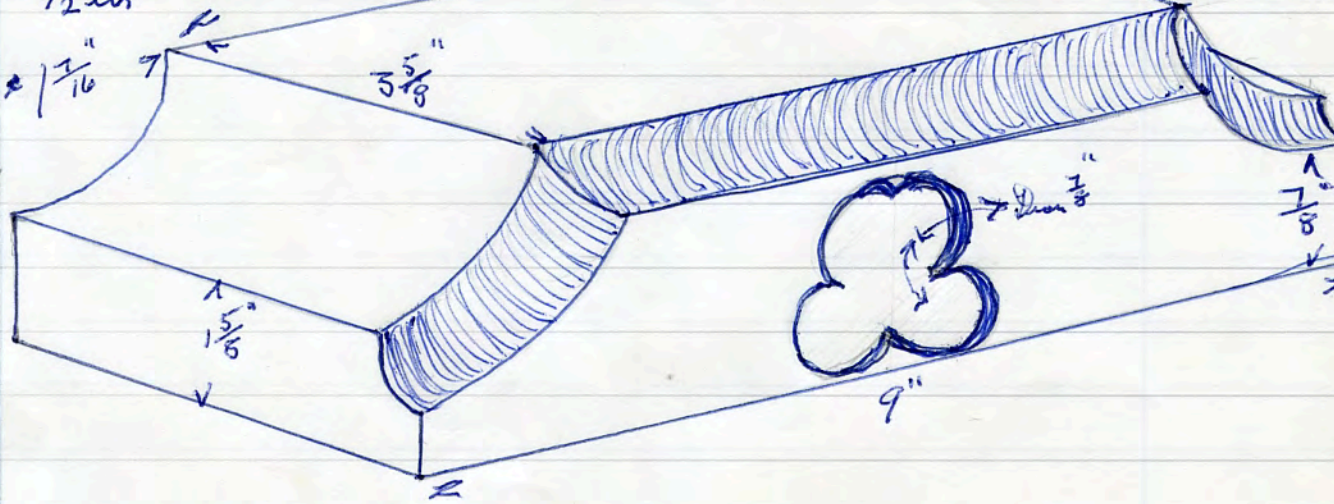

String Course Brick Clay

7 lbs

393
+

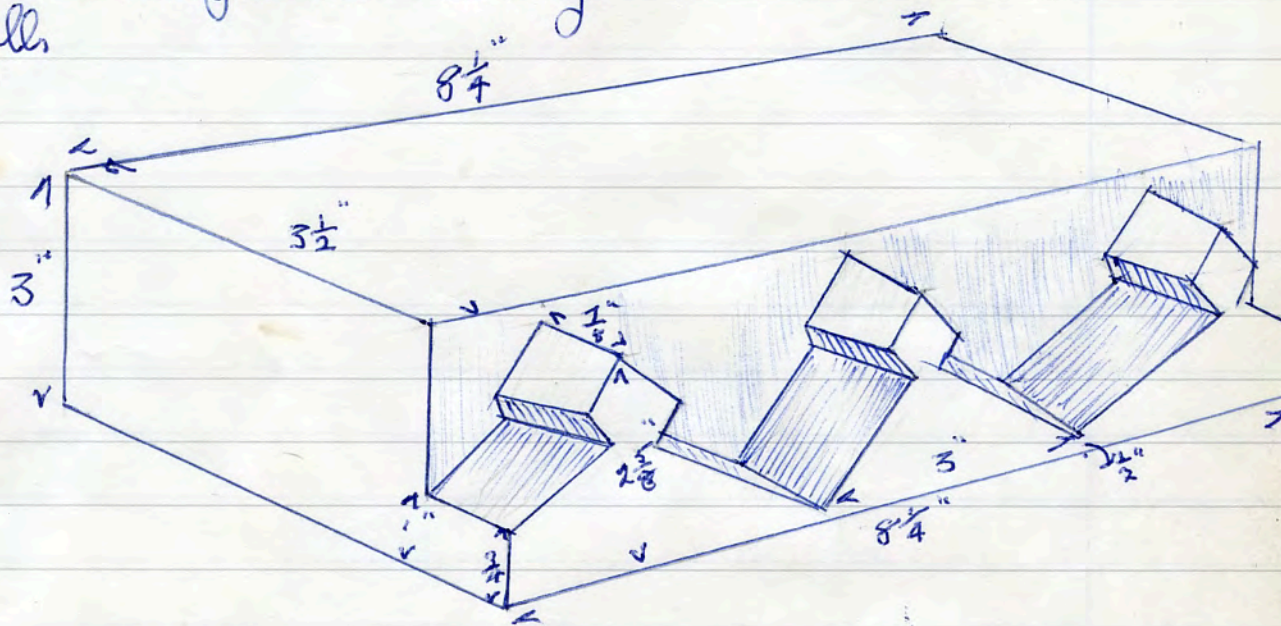

String Course Brick Clay
 $9 \times 4\frac{1}{2} \times 3$ 7 lbs

394
+

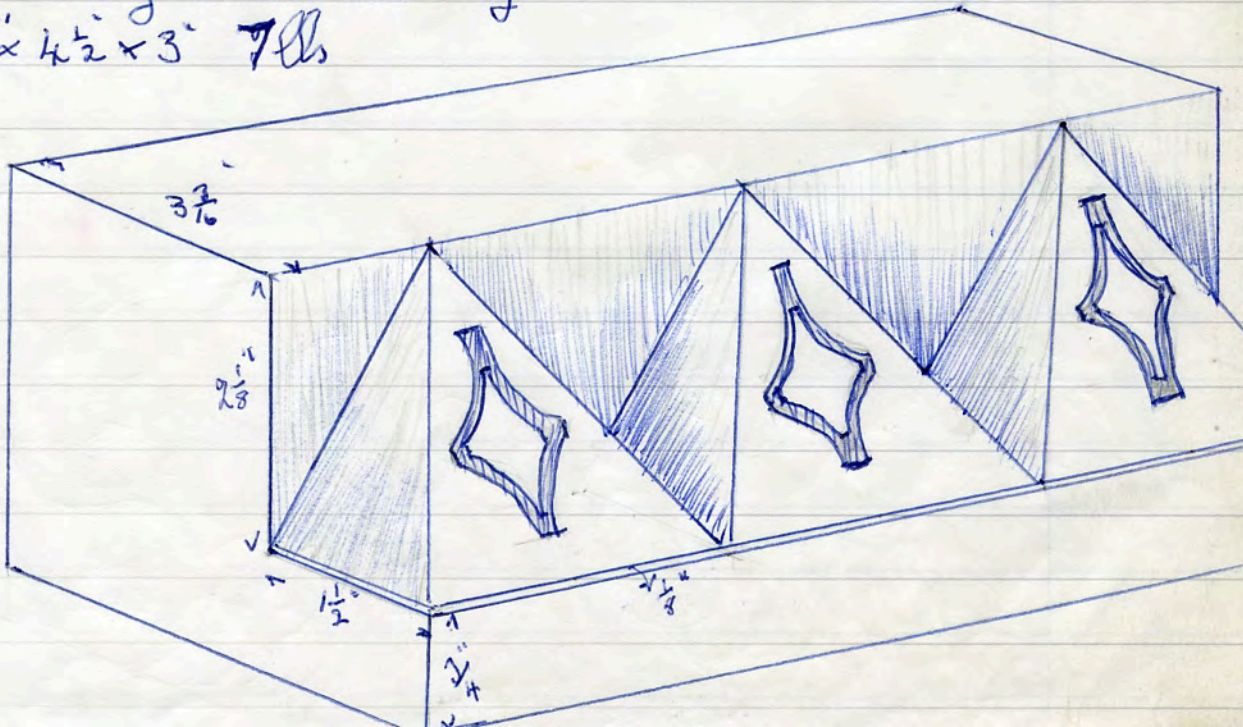

9" RD 23240

H05 x
x

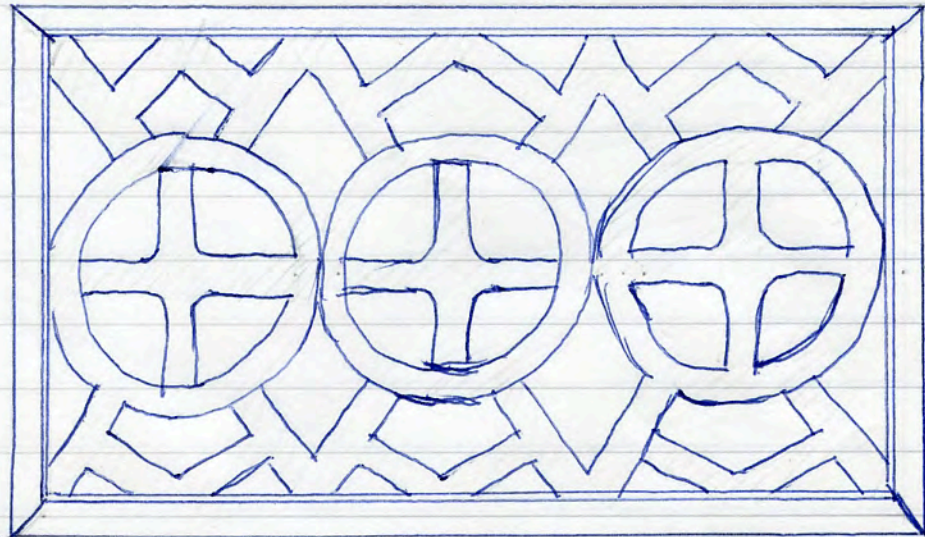

6"

6lls Ventilator brks. red. clay. 9" x 6" x 2 3/4"
RD 23240 stamped on edge. Fairsworth.

H12 x
x

(Stockpot)

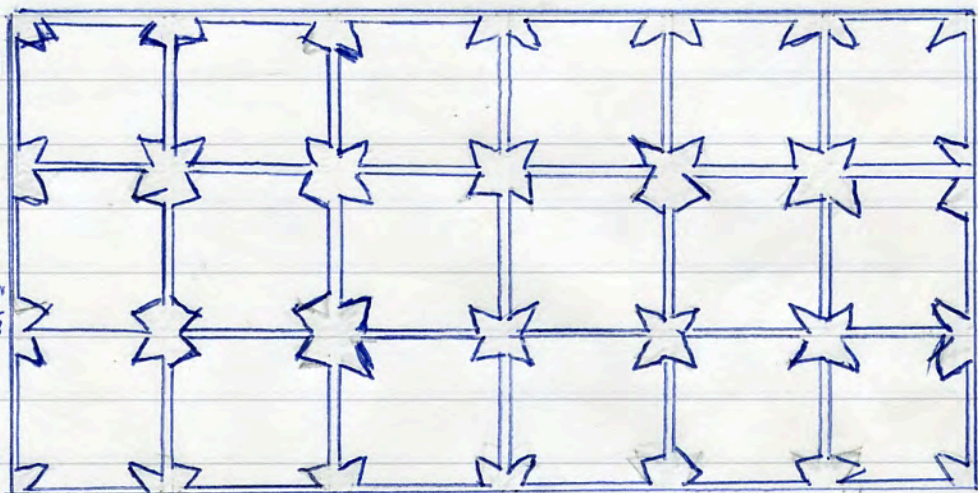

10" x 5 1/2"

7lls
Panel on Reverse
with
H₁ = Hamblett.

3. 7. '76

Air Vent. 8 1/2" x 6" x 2 1/2"

H13 x

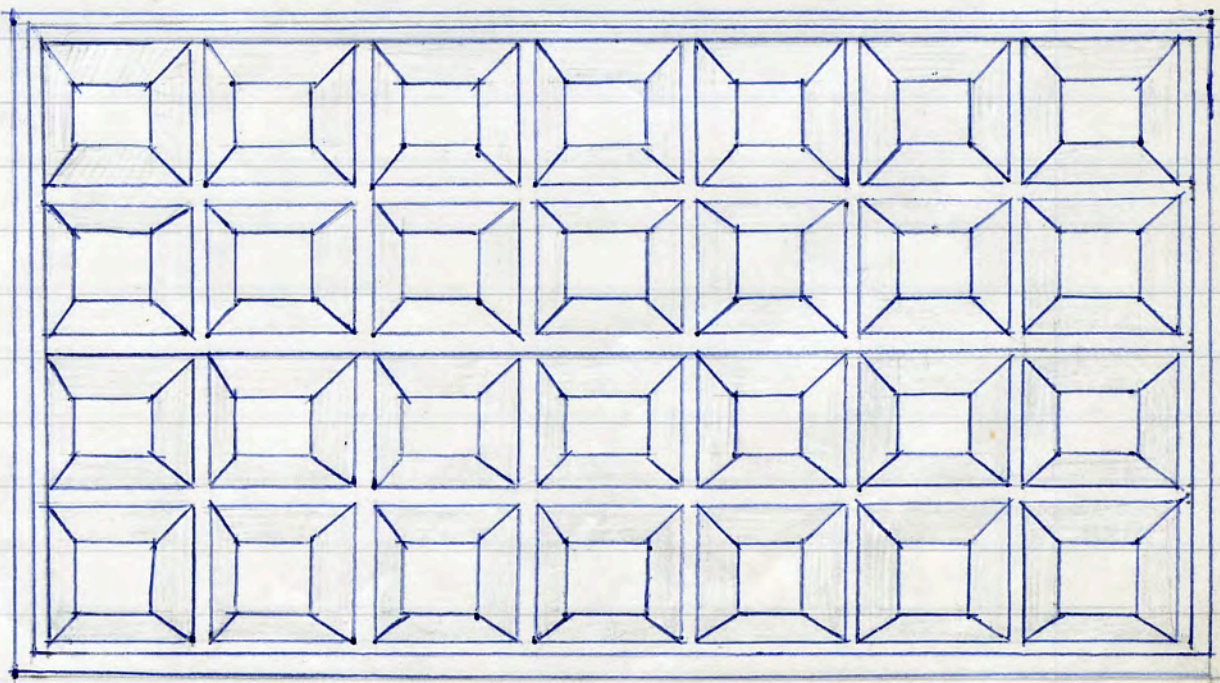

Lemacotta ventilator brick

432 x 8 1/2" x 3" x 1 1/2" black.

Pomitts Hill dem 27. 4. '76

REC NO. 371436. (marked reverse)

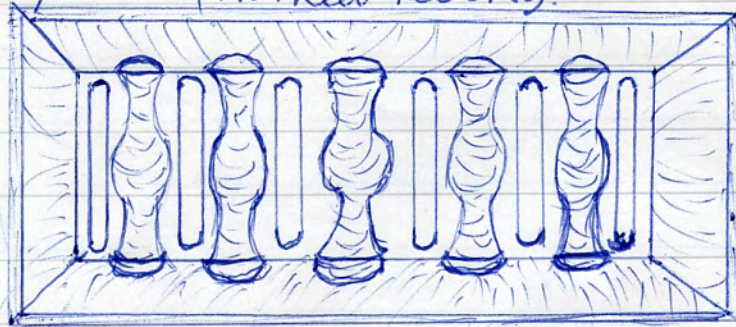

Decorative capping.

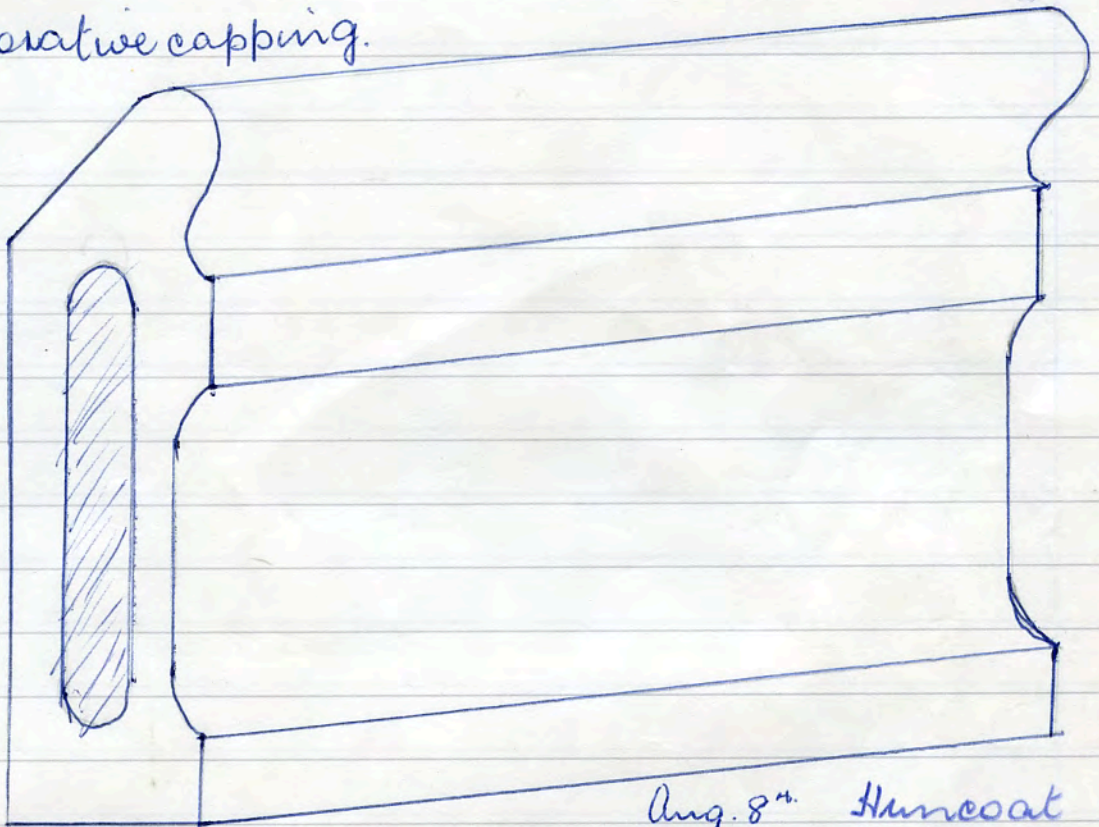

Aug. 8th Huncoat 1976

Spitter & stop end combined.

451 x

10 lb

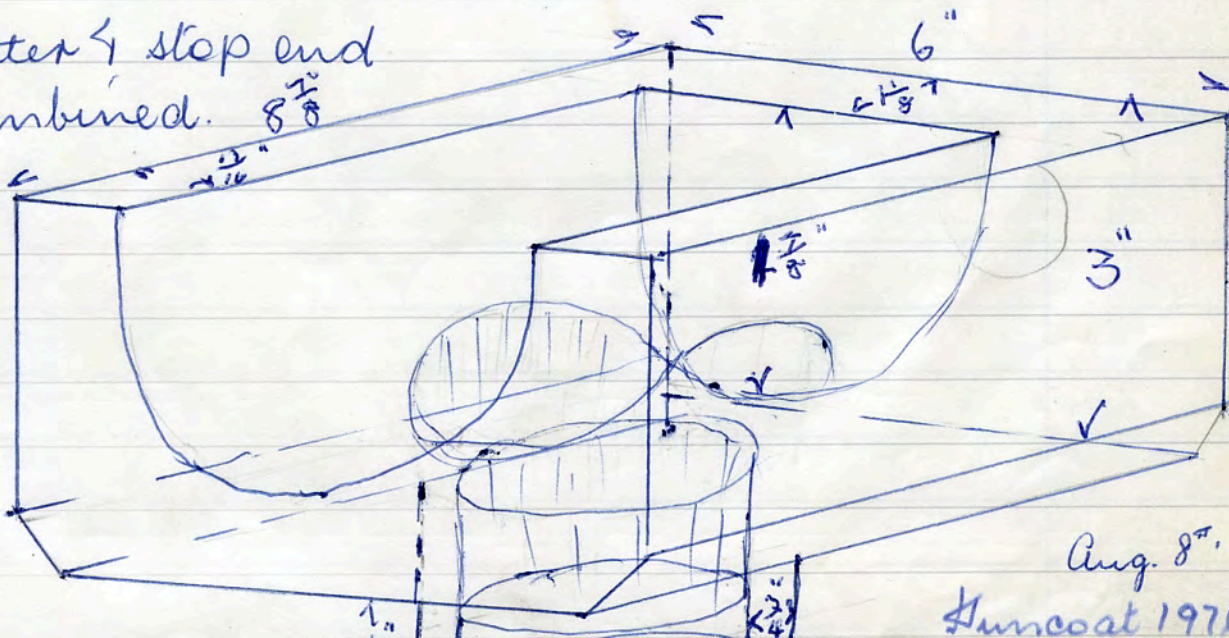

Aug. 8th
Huncoat 1976

453x

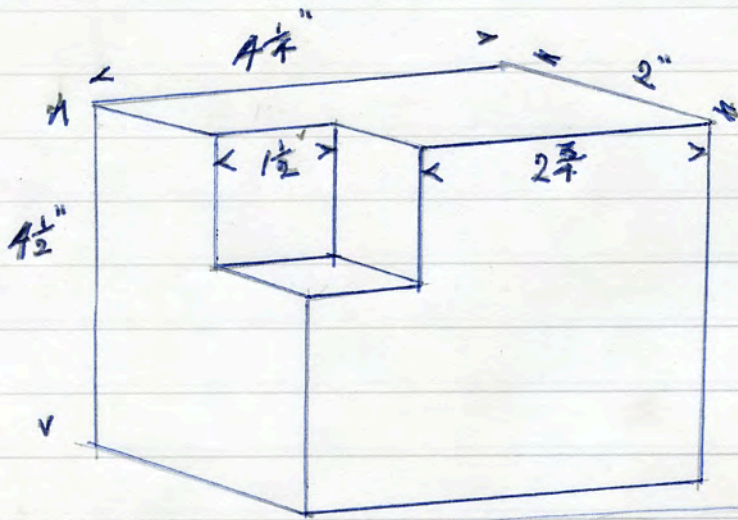

Rebated stop end.
 Huncoat 1976
 4 lbs

454x

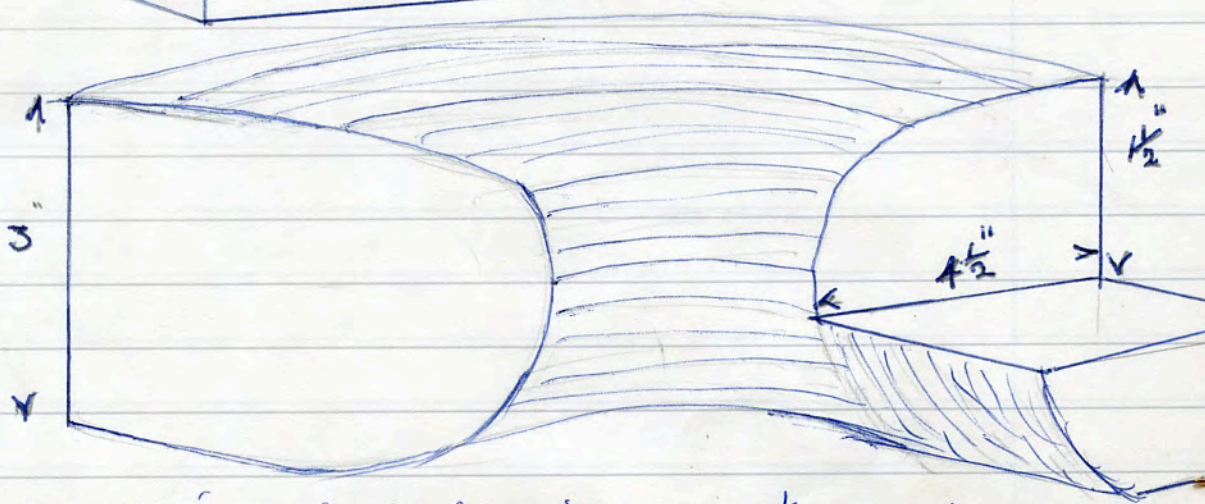

Radii section / half lap joint. Huncoat. 1976.
 Ruabon Denbigh 9 1/4" x 4 3/8" x 3 1/4"
 (Aston) Flintshire corbel
 single panel each side 8 lbs

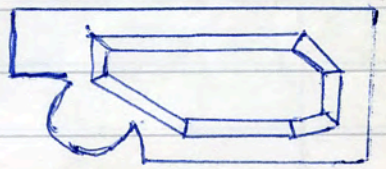

444 x 8

478 x

LBC PHORPRES

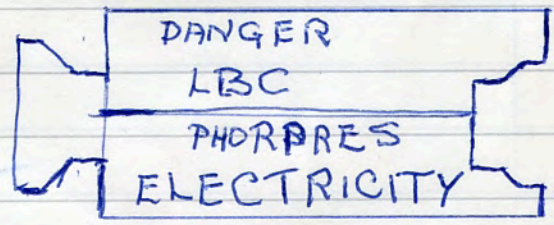

484x

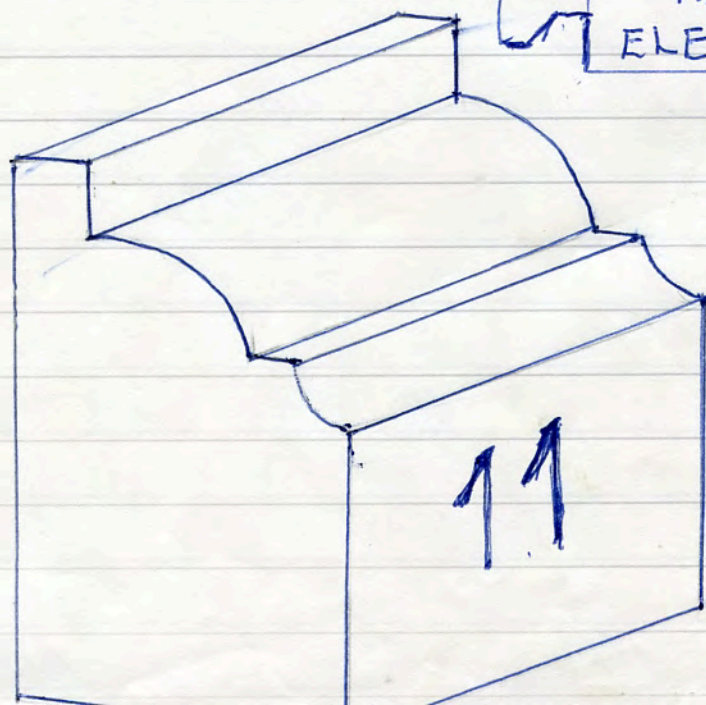

Rado or plinth sketch
 ex Kings Rialto
 House.
 Waterfoot.
 demolished Sept '46

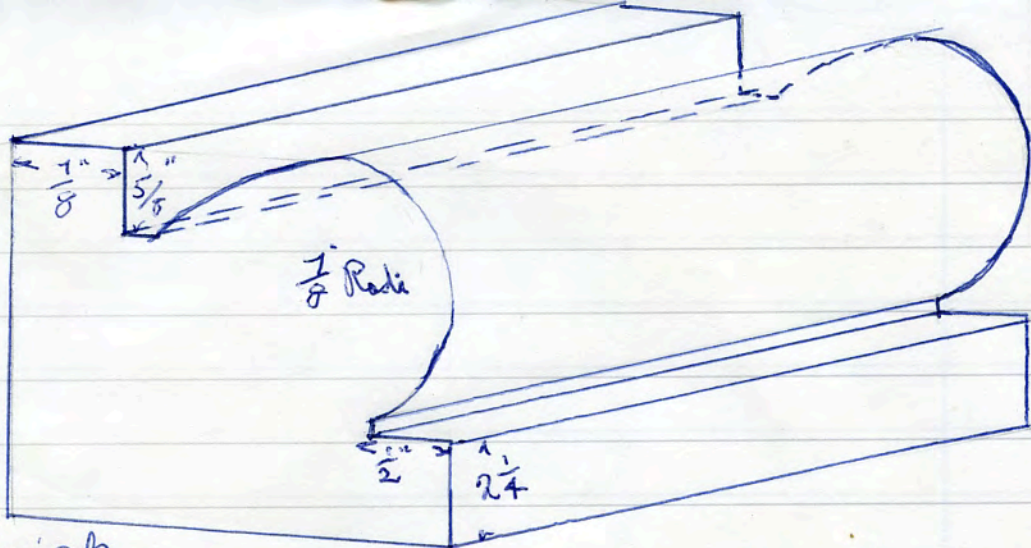

Dado brick

dem of property Gorton Rd. m/n. 80s $8\frac{1}{8} \times 4\frac{1}{4} \times 2\frac{1}{8}$

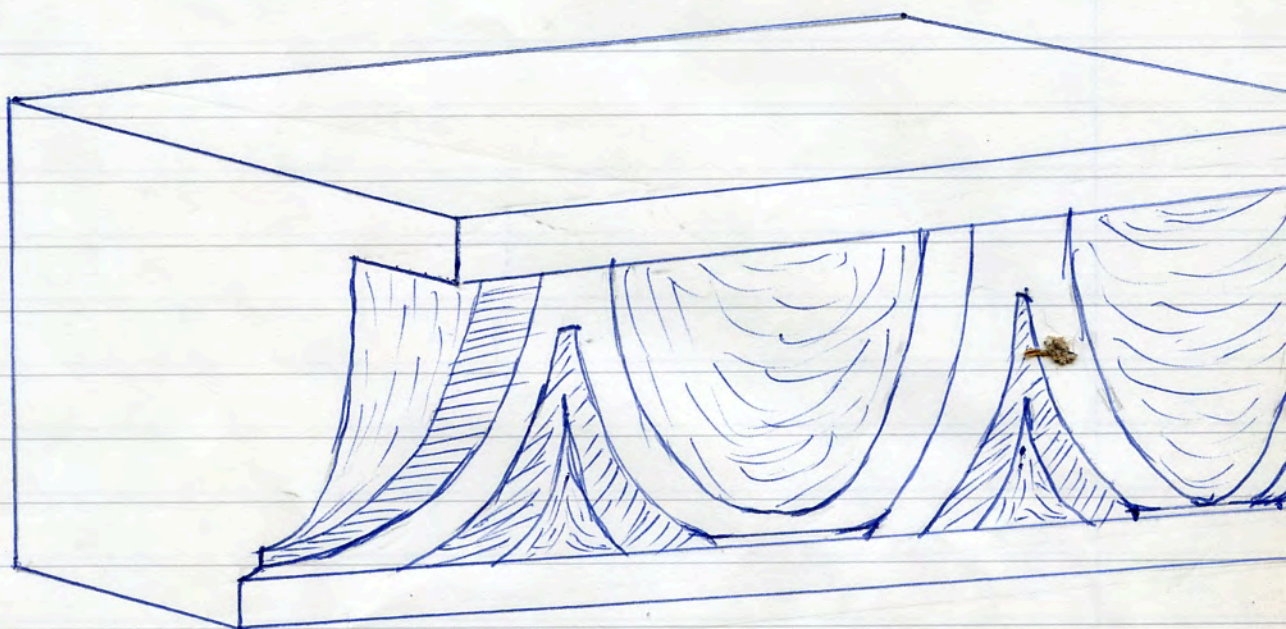

Lieze brick or Sting Course Brick 5 1/2 lbs
property dem. Gorton.

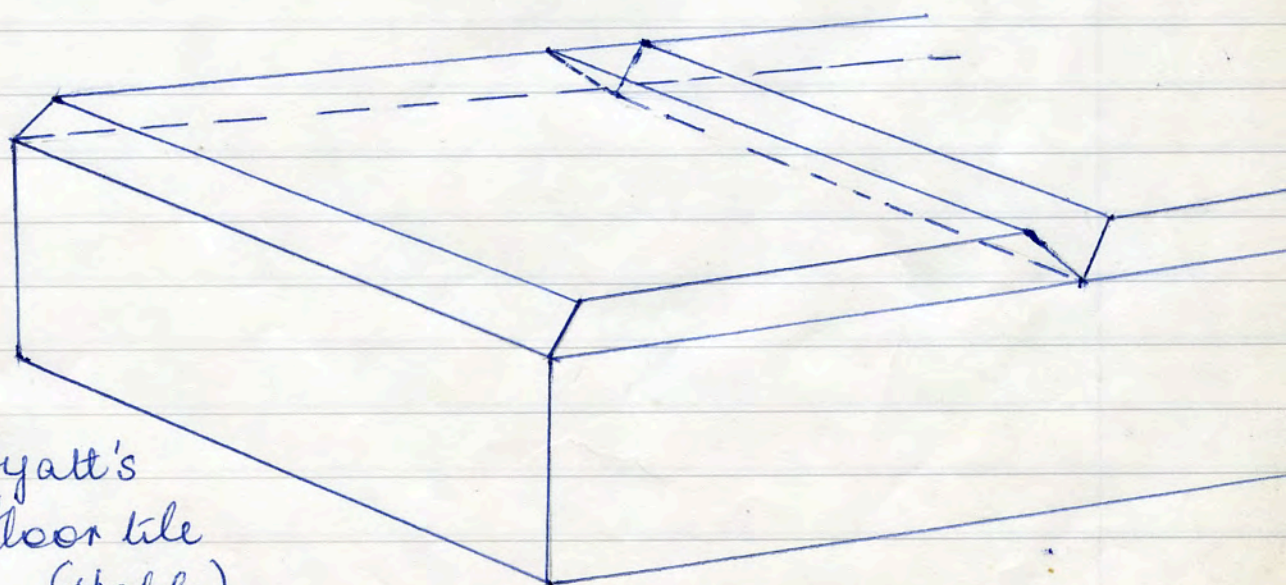

Hyatt's
floor tile
(stable)

hollow panel on reverse

503 ✓

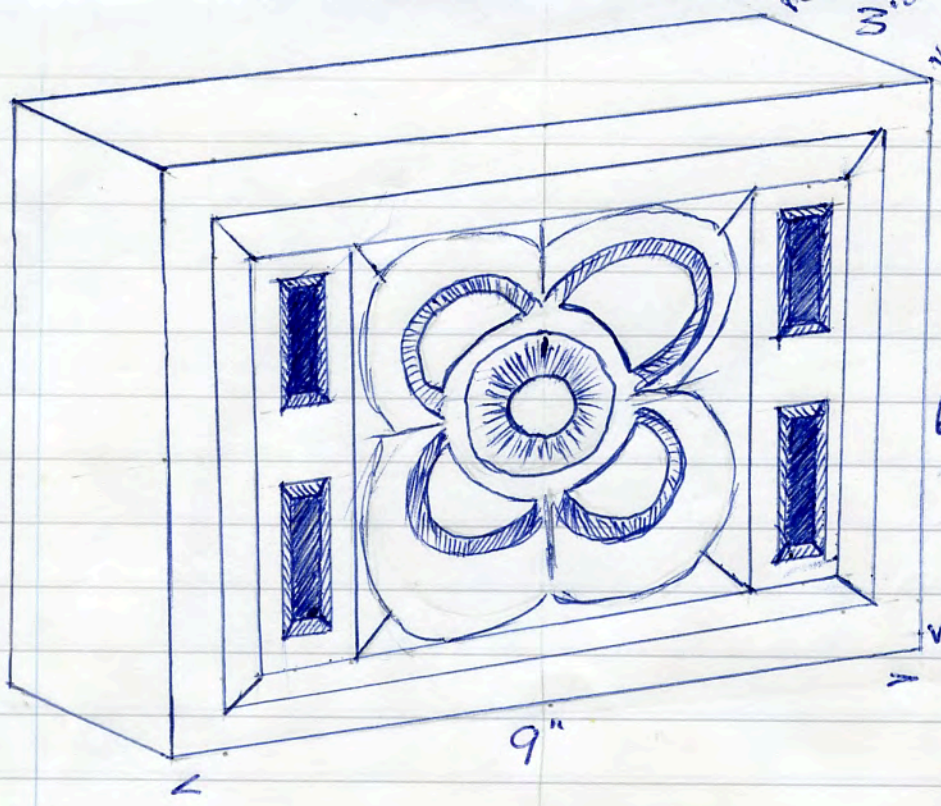

Ventilation Brick,
 ex King's Picture Hse
 demolished 1976 Sep
 7/2 lbs

6 1/2"

9"

working course Brick

Decorative Dado brick, ex Leeds
 Armley (Mr. Shutt).

504 x

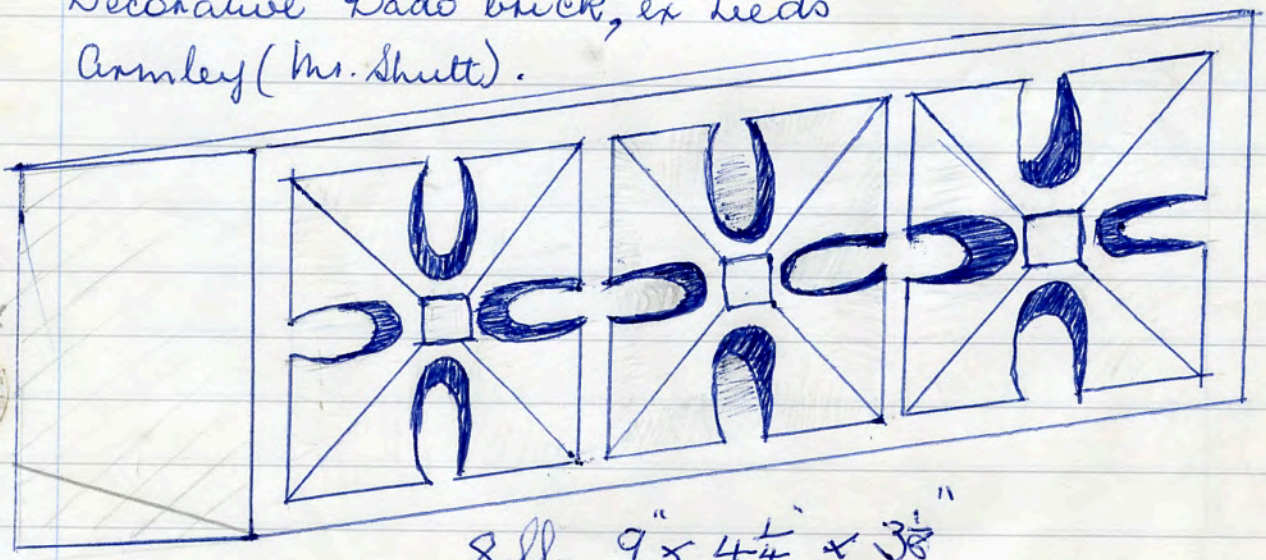

8 lb. 9" x 4 1/4" x 3 1/8"

516 ✓

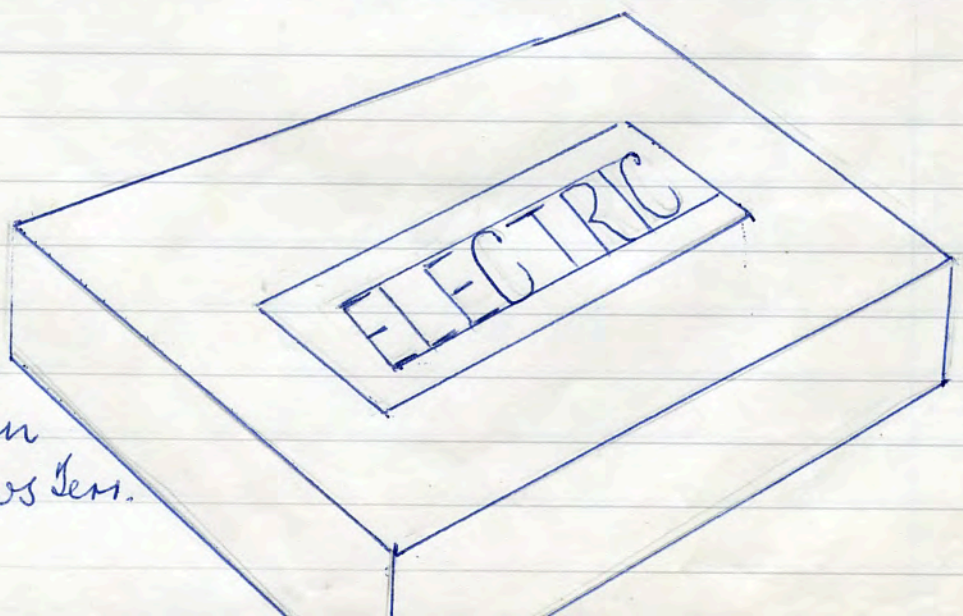

ex Ghesden
 Oddfellows Terr.

✓ 523 x DENNIS RUABON HEATHER BROWN MADE IN WALES

6" x 6" x 5/8" bull nose tile.

stamped on reverse. 3lbs.

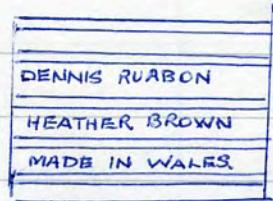

✓ x 524 9/2" x 4 1/2" x 1 5/8" brown glaze, both sides.

SHAWS TWINTILE 845 MADE IN ENGLAND double stamped on edge. 4 1/2 lbs

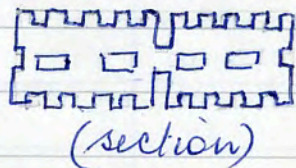

✓ x 525 9 3/4" x 4 3/4" x 1 1/4" off white glaze 1 side L 2439 on reverse. 4 1/2 lbs

unstamped

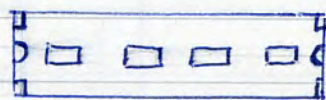

✓ x 526 9 3/4" x 4 3/4" x 1 1/4" brown & black mottled both sides. Edge stamped 4 1/2 lbs.

SHAWS TWINTILE 667 MADE IN ENGLAND

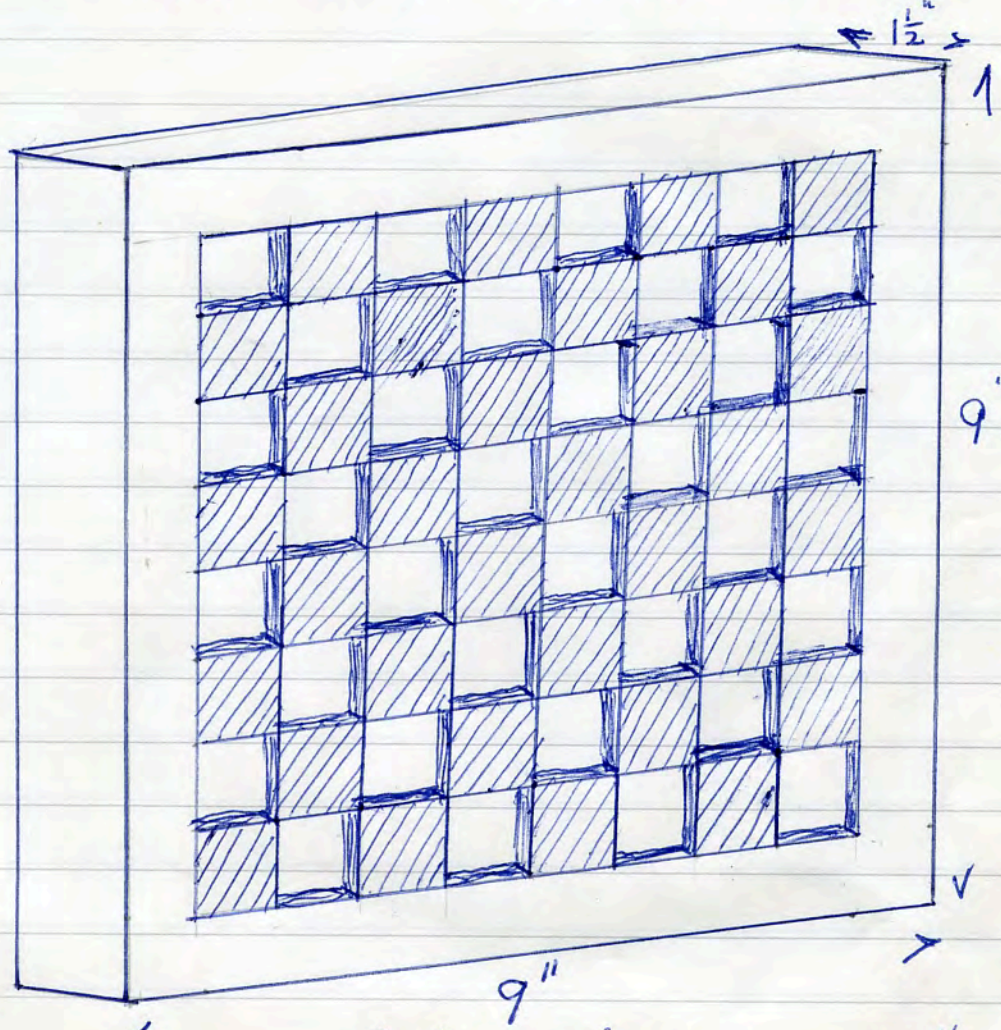

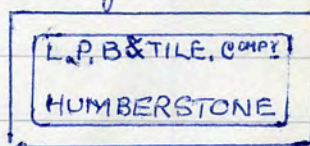

Maker - unknown ex Heywood

✓ 529 x L. P. B & TILE, COMPY. HUMBERSTONE. single panel, one side 9" x 4 1/2" x 1 1/2" 9 1/4" x 4 1/2" x 1 1/2" 4 1/2 lbs 1. 10. 76 (Mrs Shutt)

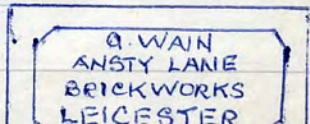

✓ x 530 G. WAIN ANSTY LANE BRICKWORKS LEICESTER. single panel one side.



Tile 6" x 6" x 1" ex Westbourne.
 stamped reverse. 25 holes $\frac{3}{16}$ " diam
 MINTON & CO. PATENT.
 STOKE UPON TRENT. 

Colours - sand, brown & white

2. 1. '47

3 1/2 lbs.

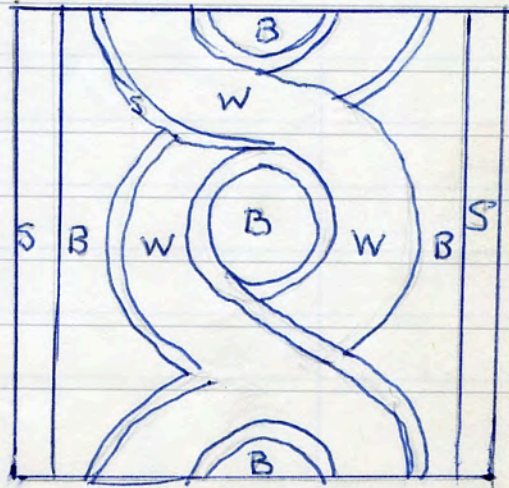

56H
 x x

HILL (Leicester) (Mr. Shutt) 1. 10. 76.
 Single panel, one side $6\frac{1}{2}$ " x $6\frac{1}{2}$ " x $\frac{1}{2}$ "
 5 1/2 lbs.



Ventilator bricks. ex King's Hall Cinema, Waterfoot. ^{Sept '46}
 7 lbs. 9" 3 1/2"

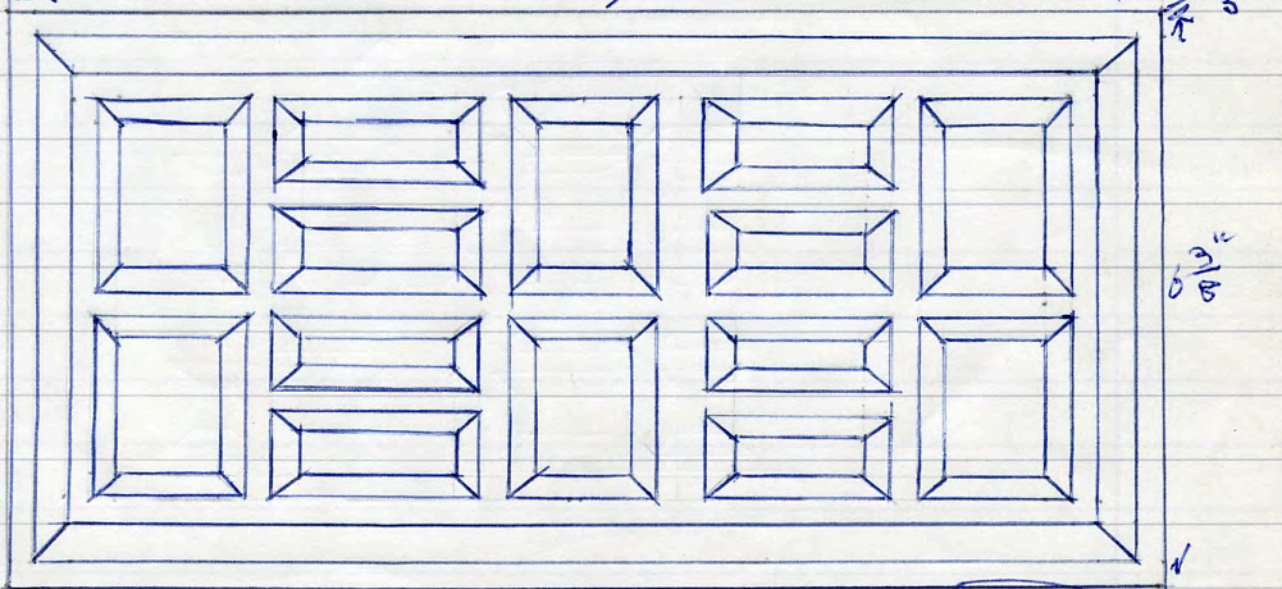

531
 x

553
 x

592.
x x

WHEATLY TRITON Ventilator brick.
MADE IN ENGLAND 9" x 3" x 2 1/2"
16 square perforations

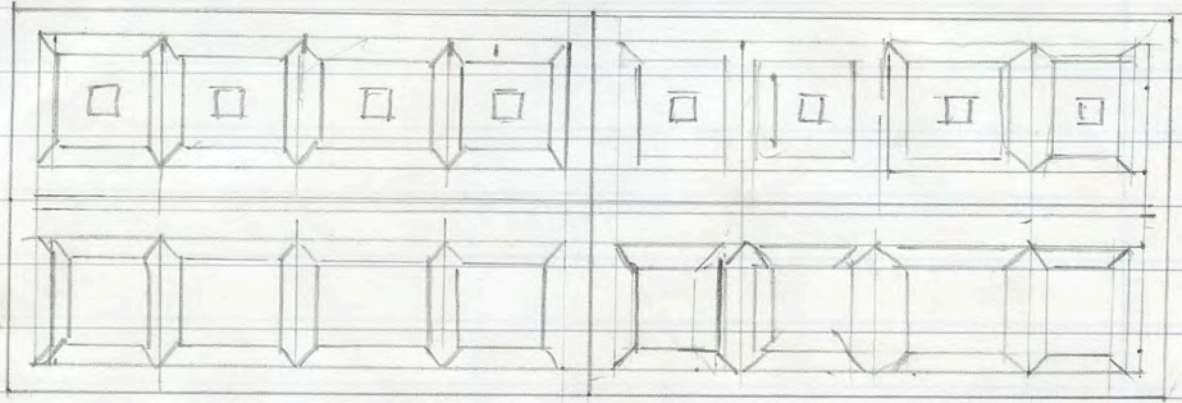

Triple dog's tooth

660
x x

Ventilator brick, ex Temperley's Bottom-shop.
8 perforations.
8 3/8" x 5 3/8" x 2 1/2"

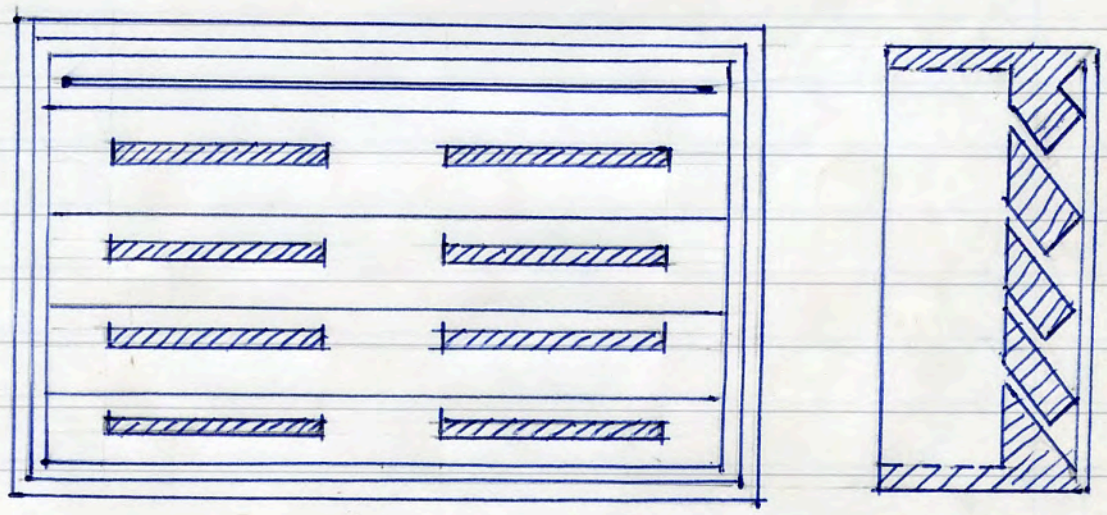

661
x

Ventilator brick.
8 perforations - 8 3/4" x 5 3/4" x 2 1/4" 5 lbs.

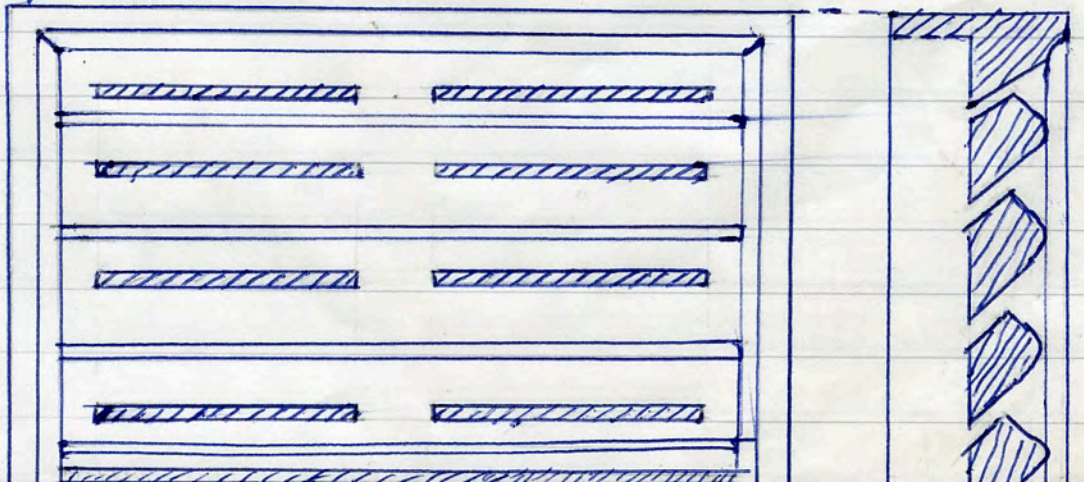

19. 6. 177

416 x

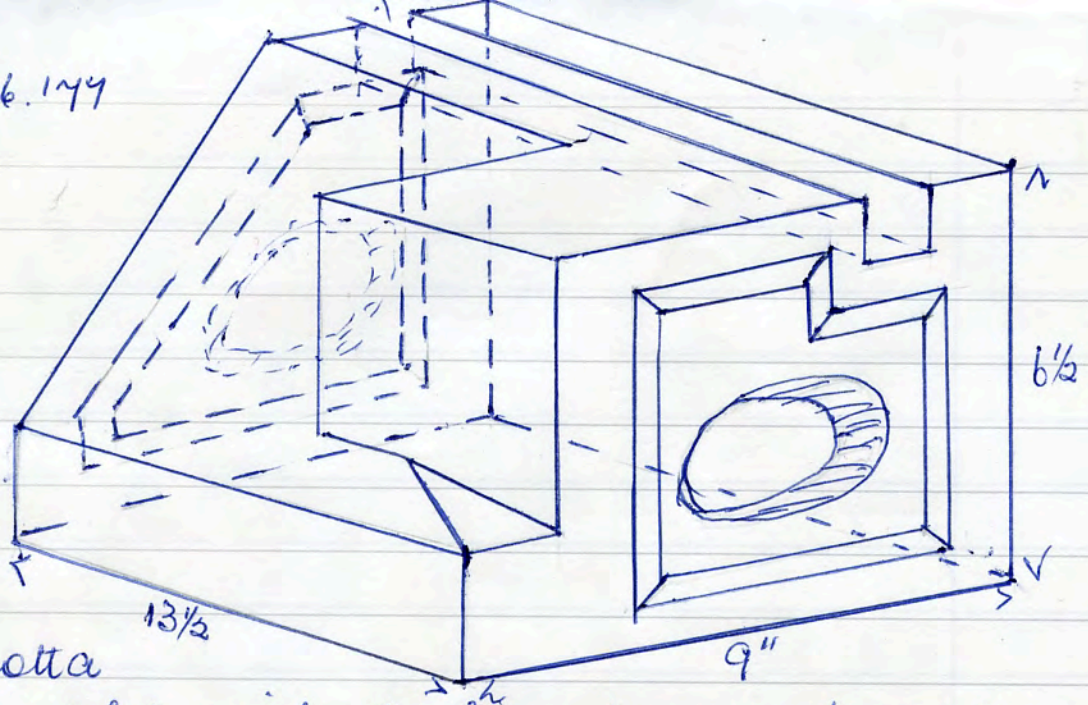

Terra cotta

fill, complete with steeling & mason's mitre and water bar.

(Mumps - Oldham)

RUABON BRICK & TERRA COTTA CO. stamped reverse

Segment of cambered moulding (Mission Hall - Oldham near Chamber bell)

19. 6. '77

414 x

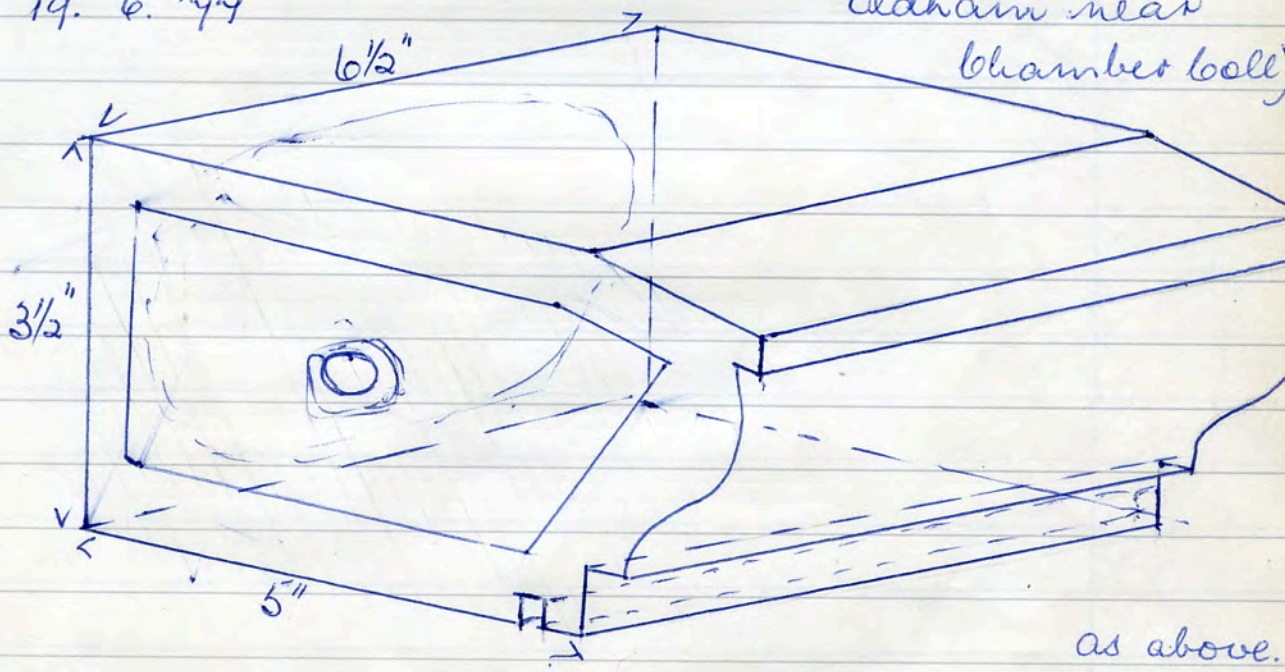

as above.

418 x

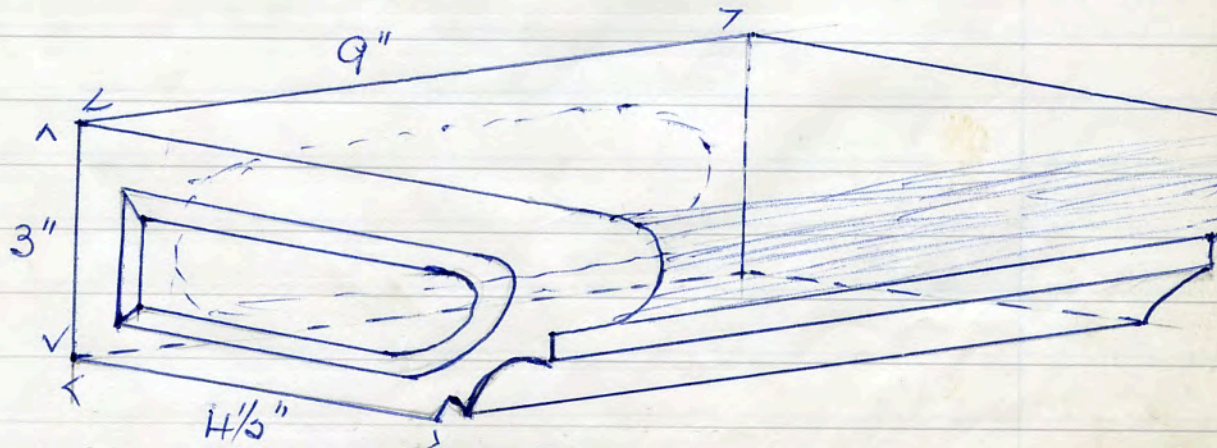

437. Terra cotta, jamb rebate piece. single panel each side. (Oldham).

9lb. Letter G article by Sambert

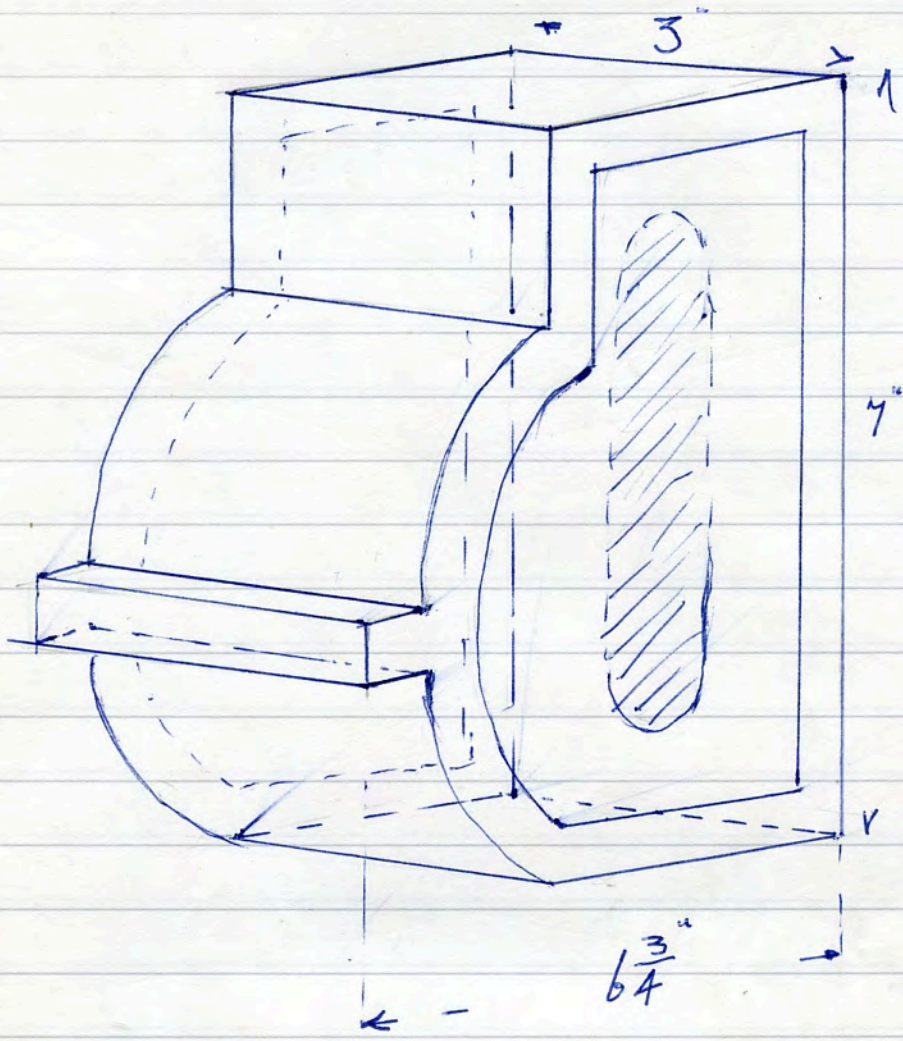

449. Tile. 6" x 3" x 1/16" 1lb
 - J C EDWARDS, RUABON, SUPERIOR ADAMANTINE. 6" x 3" Ashton Road, Openshaw.

9" x 4 3/4" x 3

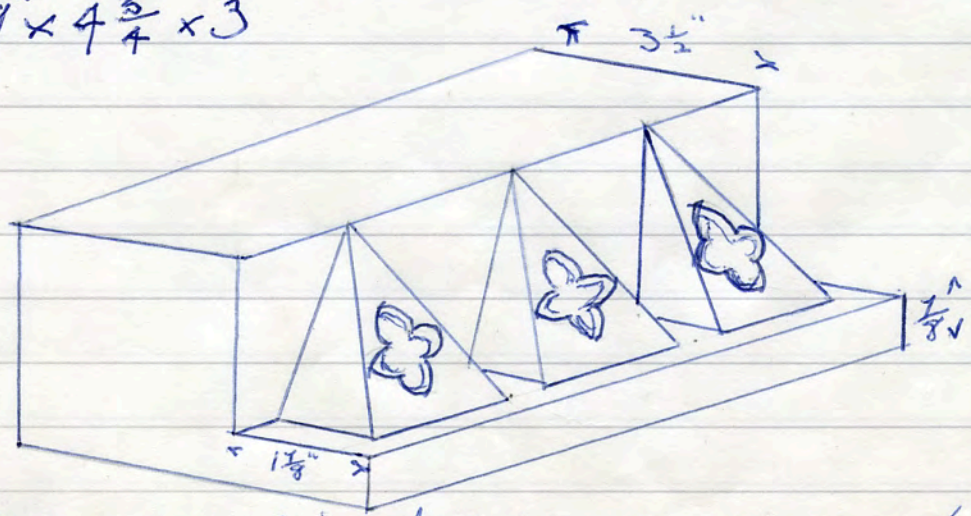

454. Decorated plinth brick - dog tooth. (10 lbs) (no name) (Helmshore - Mrs. Spencer).

Rochdale Brick Co - (no name marked)
 Return plinth brick - stop end
 (Mr Higgins).

(10 lbs)

455

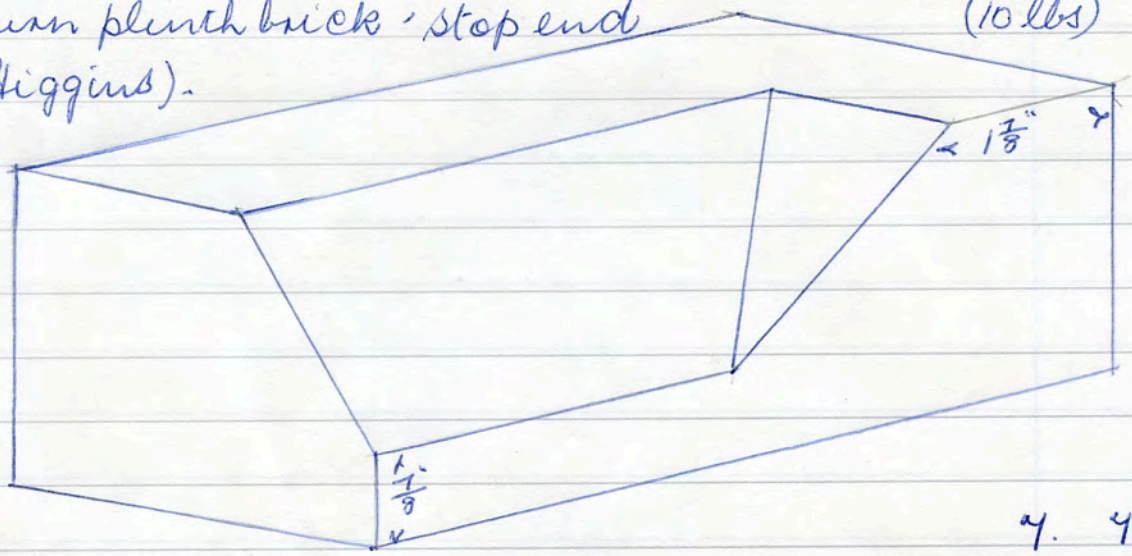

7. 4. 47

Plinth return - as above
 (8 lbs)

756

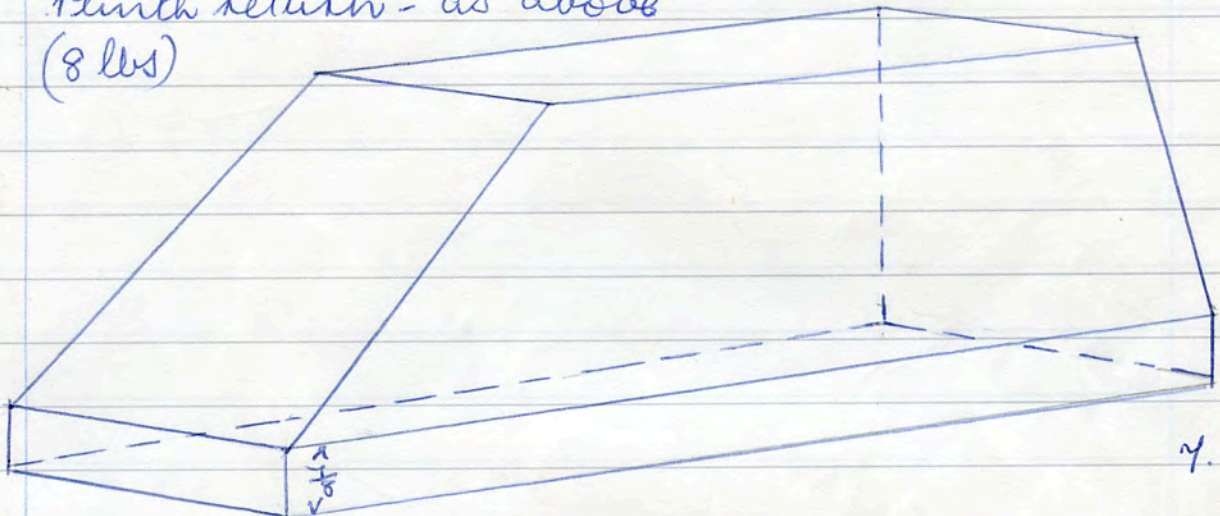

7. 4. 47

Segmental arch brick - from chimney at Rochdale
 demolished June 1944

Bk Wks
 (9 lbs)

457

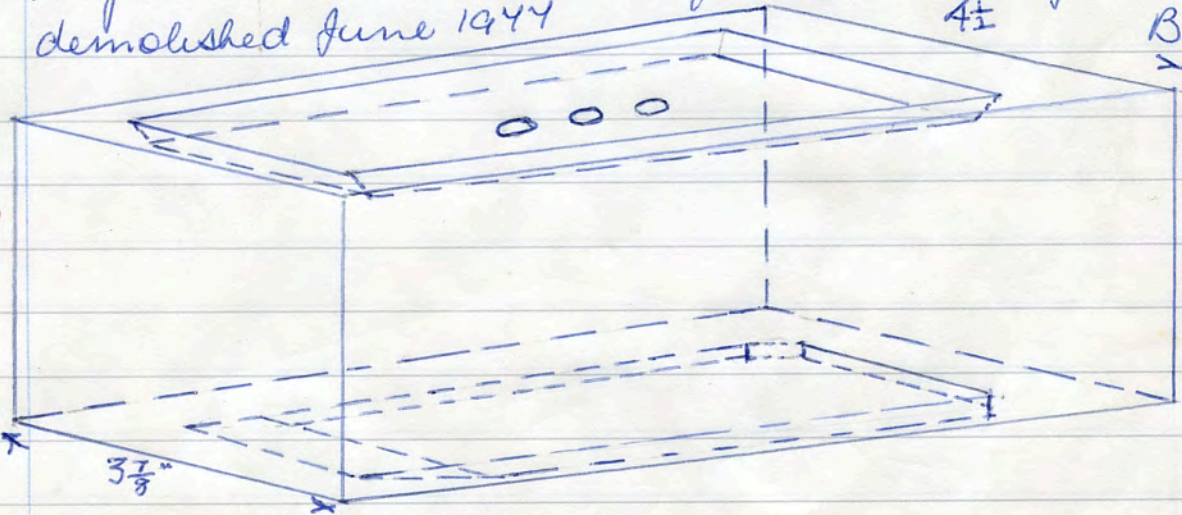

No name - corbel

7. 4. 47

788

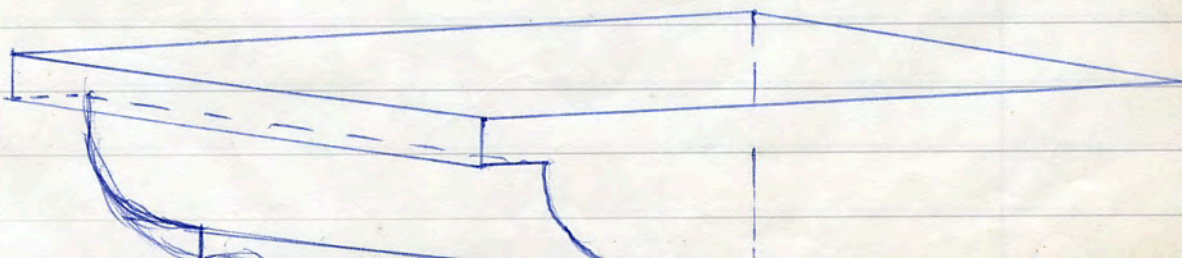

795 x

Ventilator Brick - fine clay, no name 8 1/2" x 8 1/2" x 2 3/4"
14 lbs

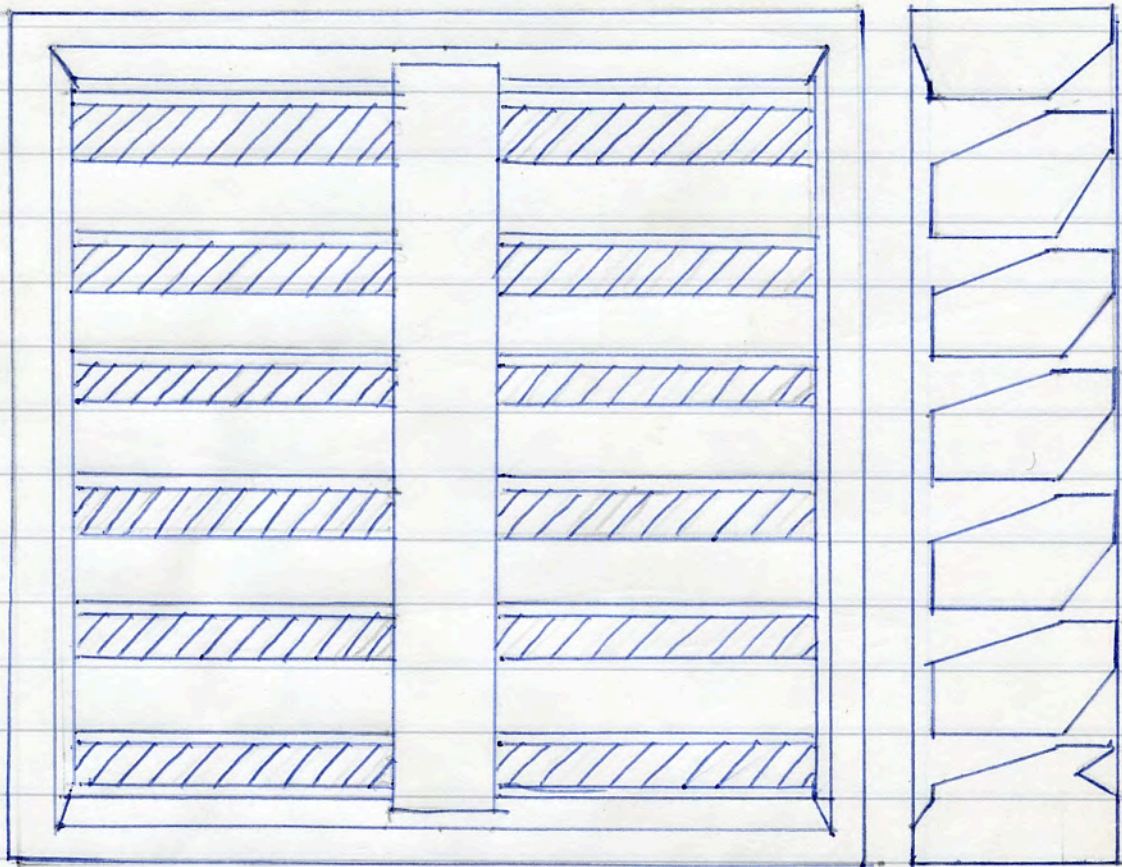

Sill return. R. B & T Co L^d (chimney demolition)
16. 8. 44.

829 x

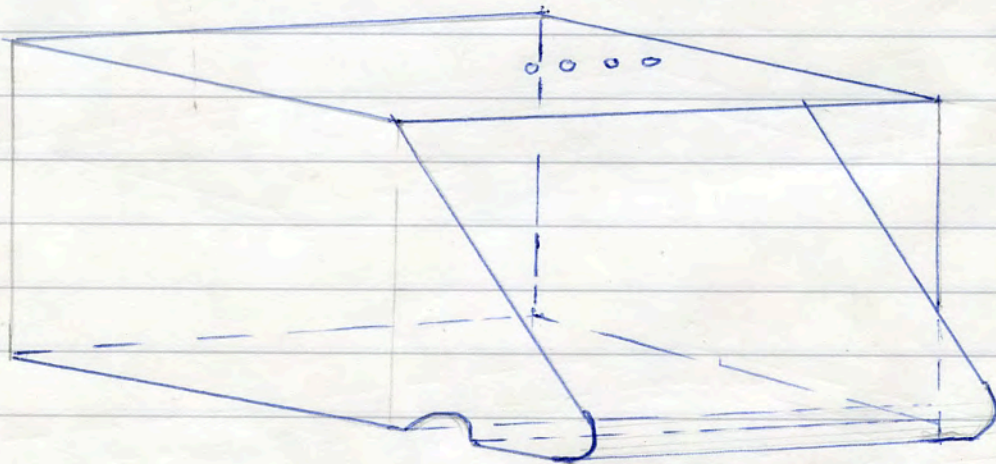

830 x

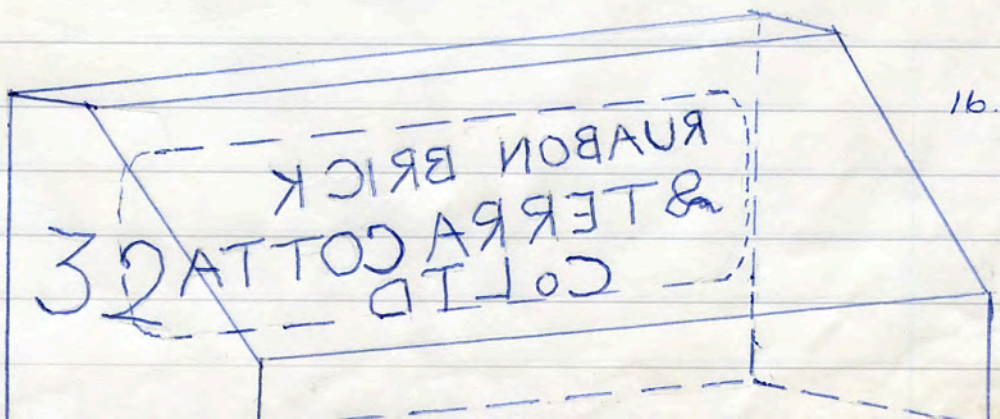

16. 8. 44

✓
869
x



red.
1/4 lb

✓
868
x

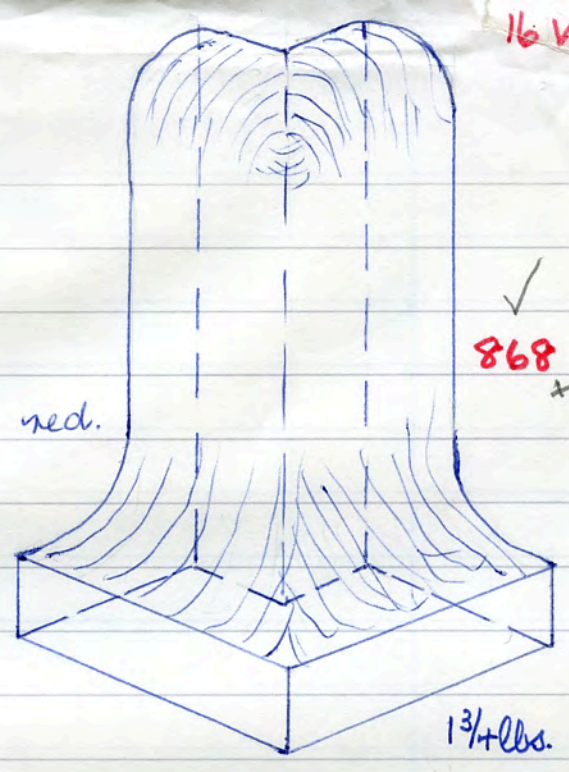

red.

1 3/4 lbs.

✓
872
x

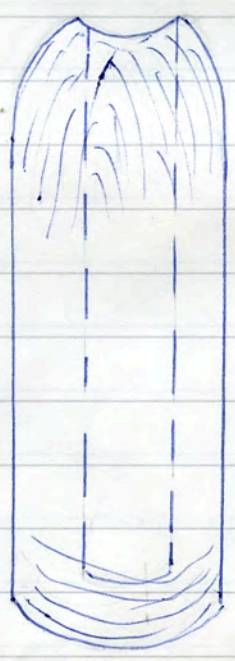

3/4 lb.
yellow

✓
870
x

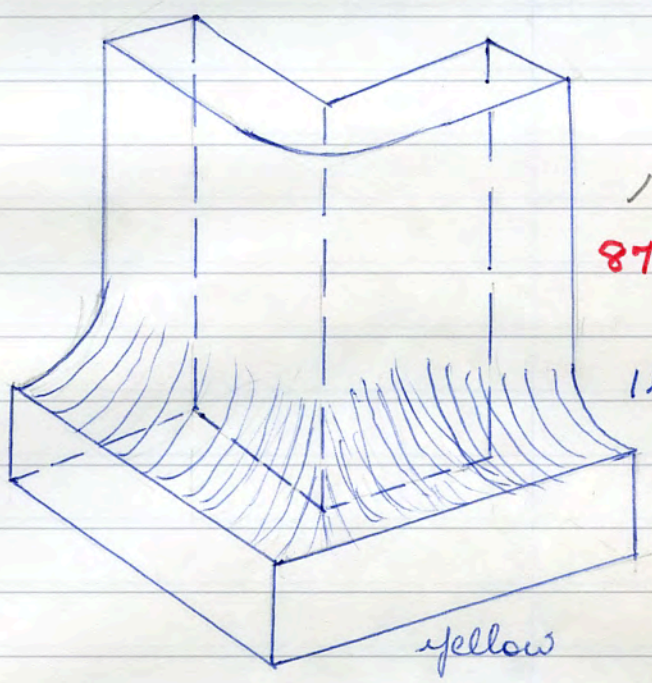

1 lb.

yellow

✓
871
x

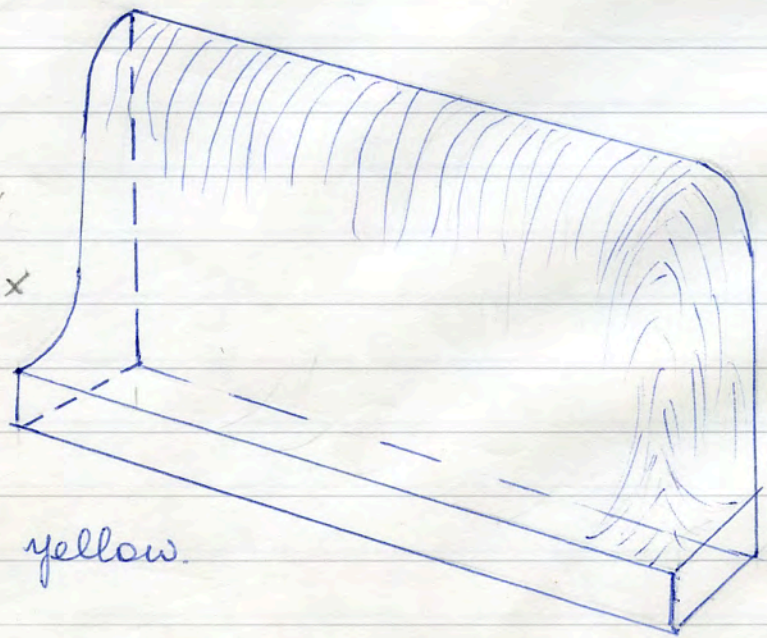

1 1/2 lbs.

yellow.

components for skirting, along with tile floor.
Ruabon Brick & Terra cotta Co. 16. 8. 44.

865
x
x

5 lbs.

$2\frac{1}{2} \times 2\frac{1}{4}$

$3\frac{3}{4}$

3

Noted
part

$6\frac{3}{8}$

6"

863
x
x

$7\frac{3}{8}$

7 lbs

$3\frac{1}{2}$ lbs.

866
x

$6 \times 6 \times \frac{3}{4}$

867
x

$2\frac{1}{2}$ lbs

$6 \times 6 \times \frac{3}{4}$ Noted Edge

Noted Edge

862
x

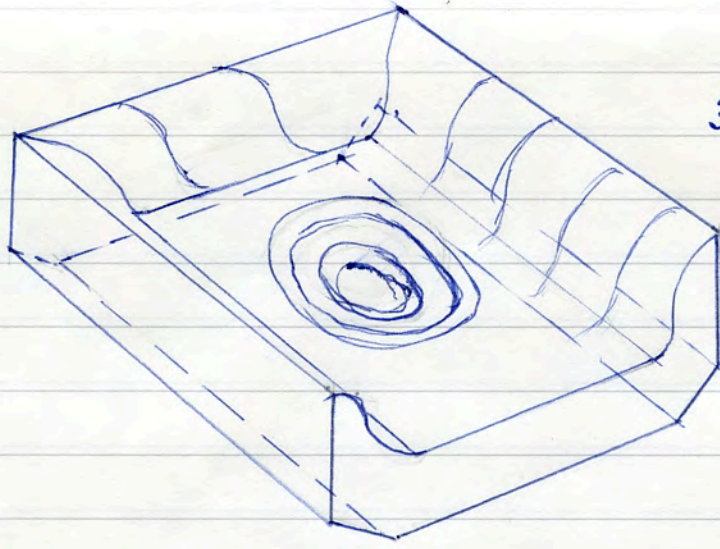

3 lbs

Sining course bricks (red)

856
848
x

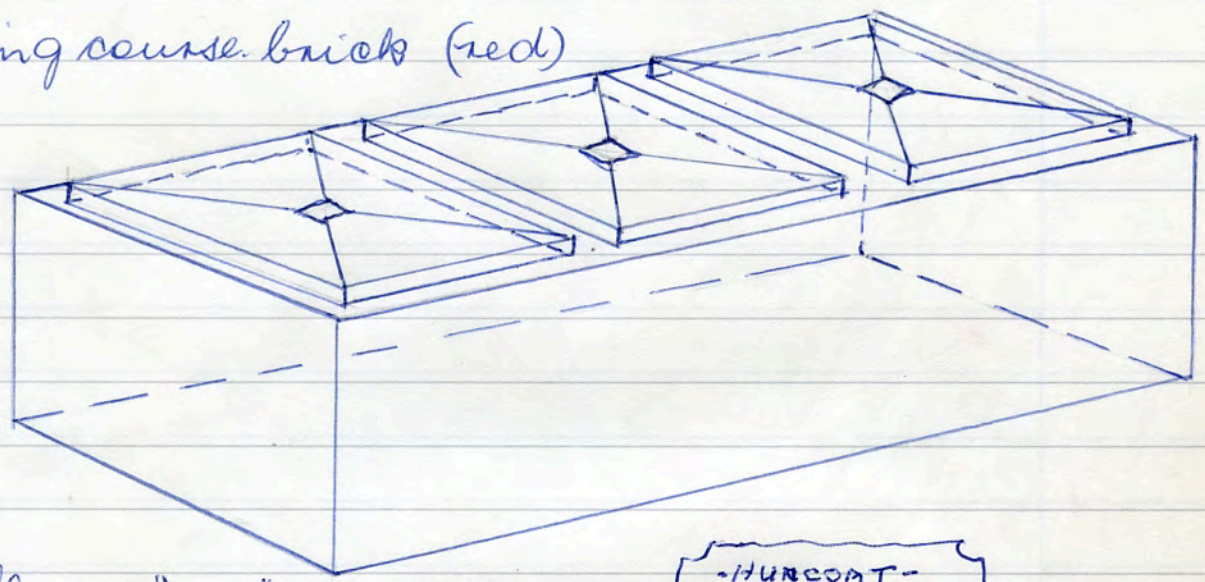

9 lbs x 9" x 4 1/2" x 3 Panel in base

HURCOAT-
PLASTIC
ACCINGTON

VITROS floor tile (black)

855
844
x

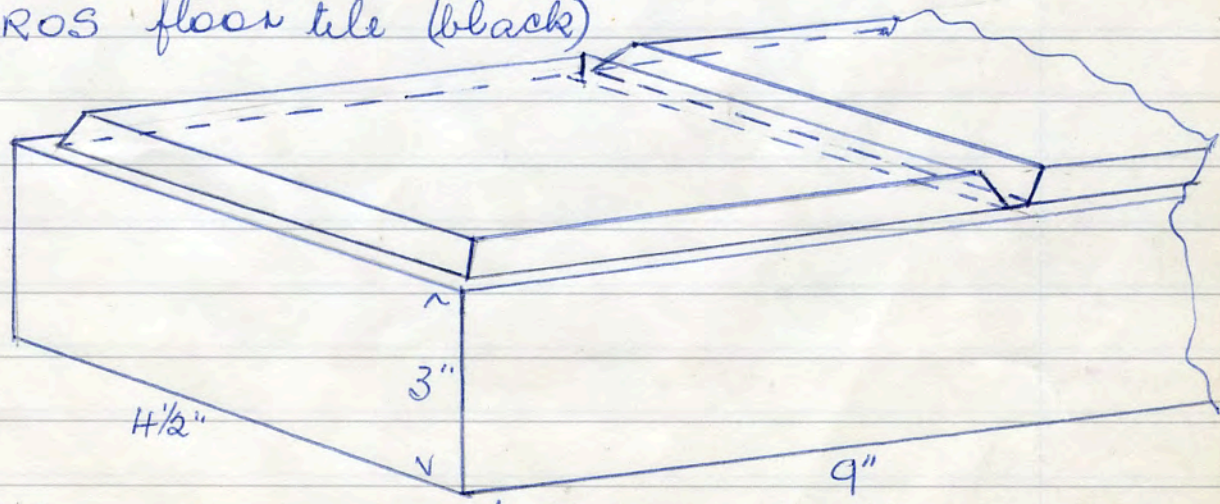

Single panel reverse. (letters in relief)

878
x

RUABON RB & TC CO LTD (yellow)
MADE IN WALES. - tile 9" x 9" x 1 1/4" return
letters in relief on reverse + throating groove.

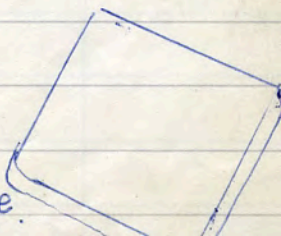

879 ✓
x x

Chamfered return with throating, bull nose Edge.

16 Z

R B & T C C^O LTD.

letters incised in panel on reverse. (2 finger marks)

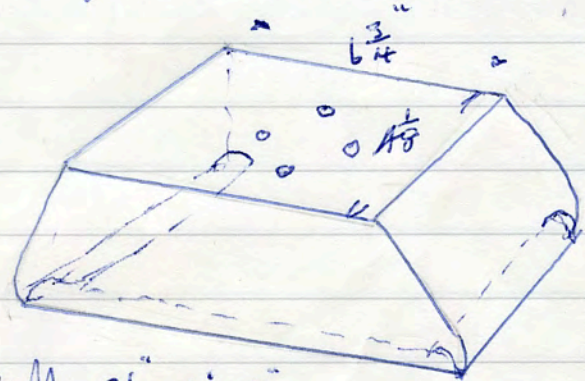

10 1/2 ll, 8 1/4 x 6 x 3

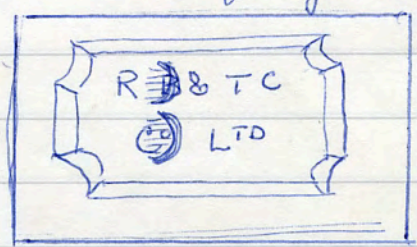

16. 8. 47

891 ✓
x

ELECTRICITY. 8 1/2" x 4 1/2" x 2"

no panel, (letters incised).
modern brick. 5 1/2 ll.

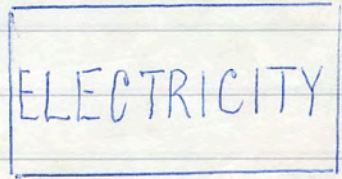

919 ✓
x x

1/2 Gauged arch ornamental brick
6 petal flower with centre boss.

SERMON on reverse. 4 1/2" x 3 1/2" = 3 1/4" x 3" 3 ll
(Hathersage Rd, Upper Brook St. M/r)

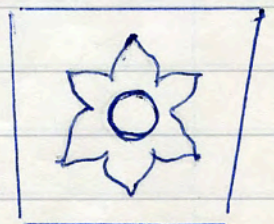

892
x 2

VITROS letters in relief in single panel - reverse diamond pattern in relief on obverse. (Mr Spence)
Found on site of demolished property near
Lincorn Football Field

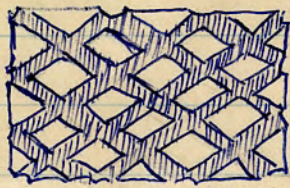

5 1/2 lbs 9 1/8" x 4 1/2" x 1 7/8"
blue

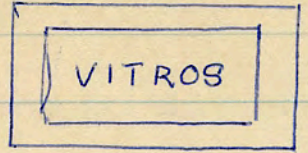

Terra cotta decorative plinth, Bheetham Public Hall
Erected 1893. 17 lbs Square in Section 4 Baths. (1. 1. 78)
Dennis Ruabon

920
x 1

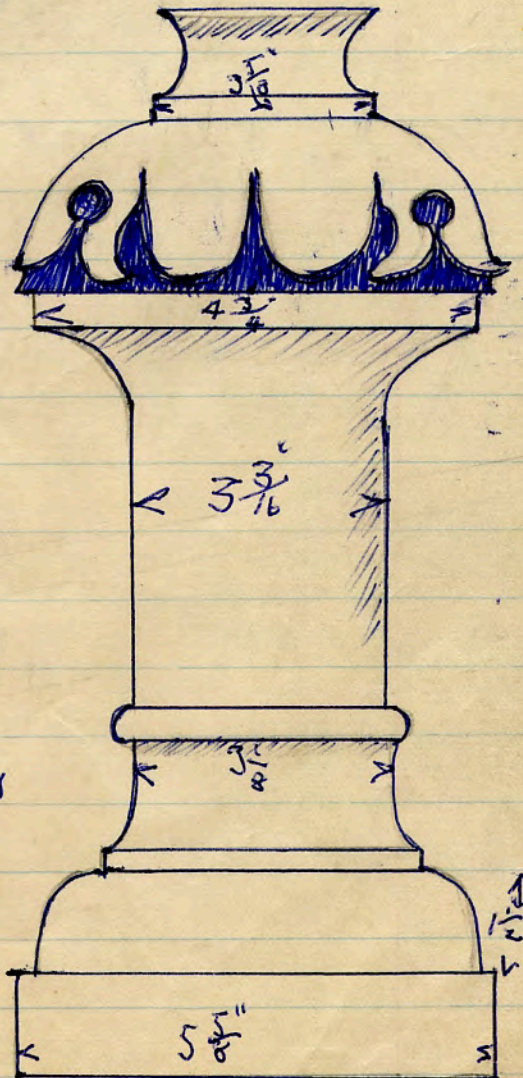

17 lbs This is Square in Section

924
x 1

Terra cotta decorative finial
Dennis Ruabon
Bheetham Public Hall & Baths
(8. 1. 78)

✓ Partition brick - $11\frac{1}{2}'' \times 5\frac{1}{2}'' \times 4\frac{1}{2}''$
 918. ✕
 4 perforations through - $3'' \times \frac{5}{8}''$
 12 serrations for plaster. no name. (Rochdale Bricks Co)
 Terra cotta sill piece

✓ DENNIS RUABON (stamped) B 21. $\frac{1}{2} lb$
 921 ✕
 perforation $1\frac{1}{4}''$ diam. $7'' \times 3'' \times 3''$
 (Cheetham Public Hall m/r.)

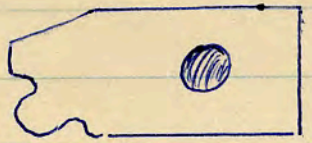

✓ Terra cotta mullion section 8 lbs.
 922 ✕
 perforation $2\frac{1}{2}'' \times 2''$. $4\frac{1}{2}'' \times 5\frac{3}{4}'' \times 3''$
 stamped DENNIS RUABON. (Cheetham Public Hall m/r.)

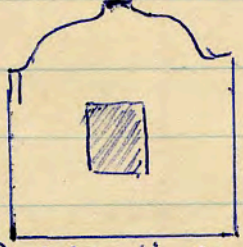

✓ Terra cotta window quoin $6\frac{3}{4}'' \times 9'' \times 3''$.
 923 ✕
 stamped B 4 (Dennis Ruabon)
 (Cheetham Public Hall m/r.)
 perforation

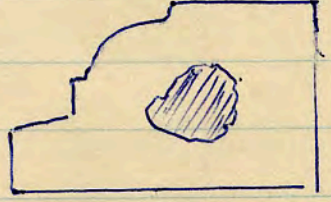

✓ Broken piece of decorative
 950 ✕
 terra cotta from Cheetham
 Public Hall. 7 lbs.
 (Part of Acanthus design.
 No. 1. '78



✓ Road or Rly Station tile $9'' \times 9'' \times 2\frac{1}{4}''$.
 952 ✕
 blue. No name. Diamond pattern in
 Waterfoot Rly cottages. 14 lbs. relief.

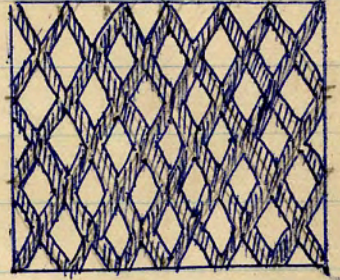

✓ border brick. no name.
 single panel each side
 974 ✕
 (Princess Road Manchester.)

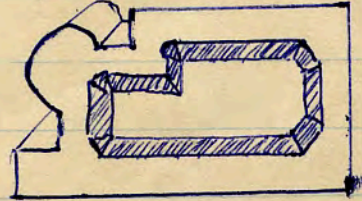

✓ cornice - decorative. $9'' \times 4\frac{3}{4}'' \times 3''$
 975 ✕
 no name, plain reverse. 8 lbs.
 (Cheetham Public Hall m/r.)



982 x x
 Tenna cotta no name (Ruabon?)
 $9\frac{1}{4}'' \times 6\frac{1}{4}'' \times 3\frac{1}{2}''$ 7 lbs.
 (Cheetham Public Hall)



983 x
 Tenna cotta, wall capping junction
 (Cheetham Public Hall)
 $13\frac{1}{4}'' \times 6\frac{1}{2}''$
 panel in each end

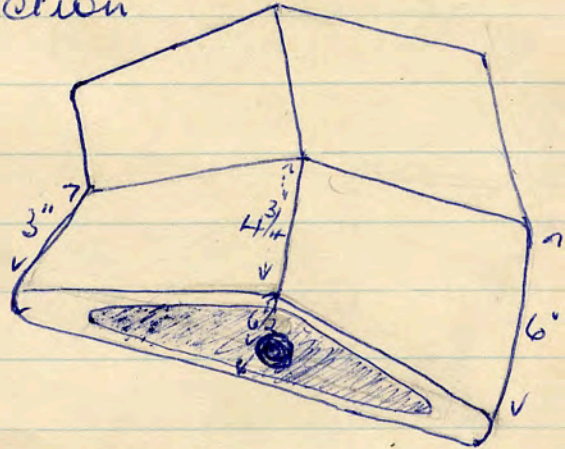

984 x x
 Hard burnt blue (iron) Moss Hill Rochdale
 standard wall capping for L & Y Rhybo's bridges
 Fine clay, boiler house flag, used as lagging
 $18'' \times 13''$ 2 rebates - opposite.
 R. B. Seville's Bakehouse.
 rebates $\frac{3}{4}'' \times 1'' \times 1''$, no name.

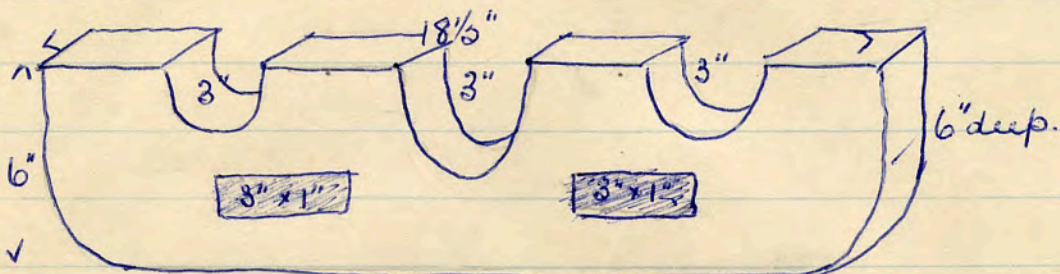

985 x
 Tenna cotta sill piece, $9'' \times 4\frac{1}{2}'' \times 3''$
 no name. (Pendleton Rd. M/r.)

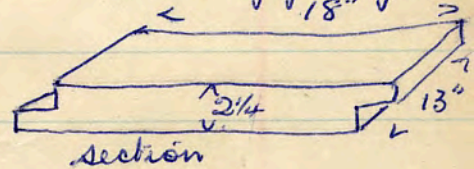

989 x
 Tenna cotta sill piece, $9'' \times 4\frac{1}{2}'' \times 3''$
 no name. (Pendleton Rd. M/r.)

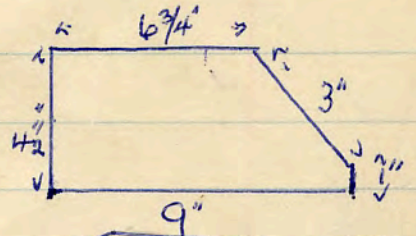

990 x
 Tenna cotta plinth $9'' \times 5\frac{1}{2}'' \times 3''$
 panel on base - no name
 (Pendleton Rd. M/r.)

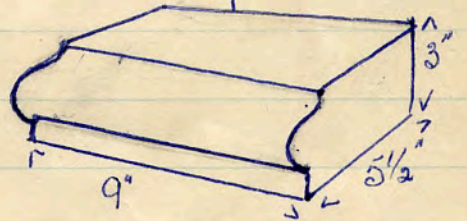

991 x
 Tenna cotta plinth return $9'' \times 6\frac{1}{2}'' \times 3''$
 panel on base - no name
 (Pendleton Rd. M/r.)

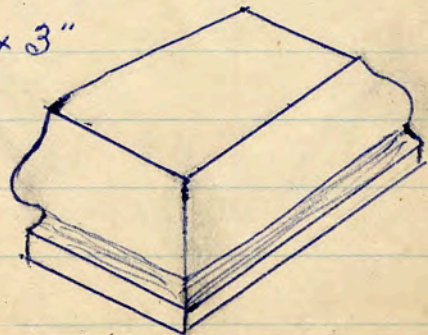

993

ELECTRICITY L BALDWIN T
8 3/4" x 1 1/4" x 1 3/4" letters incised

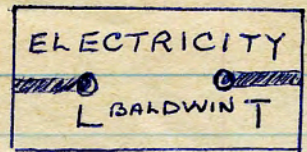

1 fine clay ventilator. ex Rochdale Pioneers Stables.
2 parts - one to fix as ridge tile to support ventilator.
Stamped HALL & ROGERS, SMITHY BRIDGE,
Summer St off Walpole St.

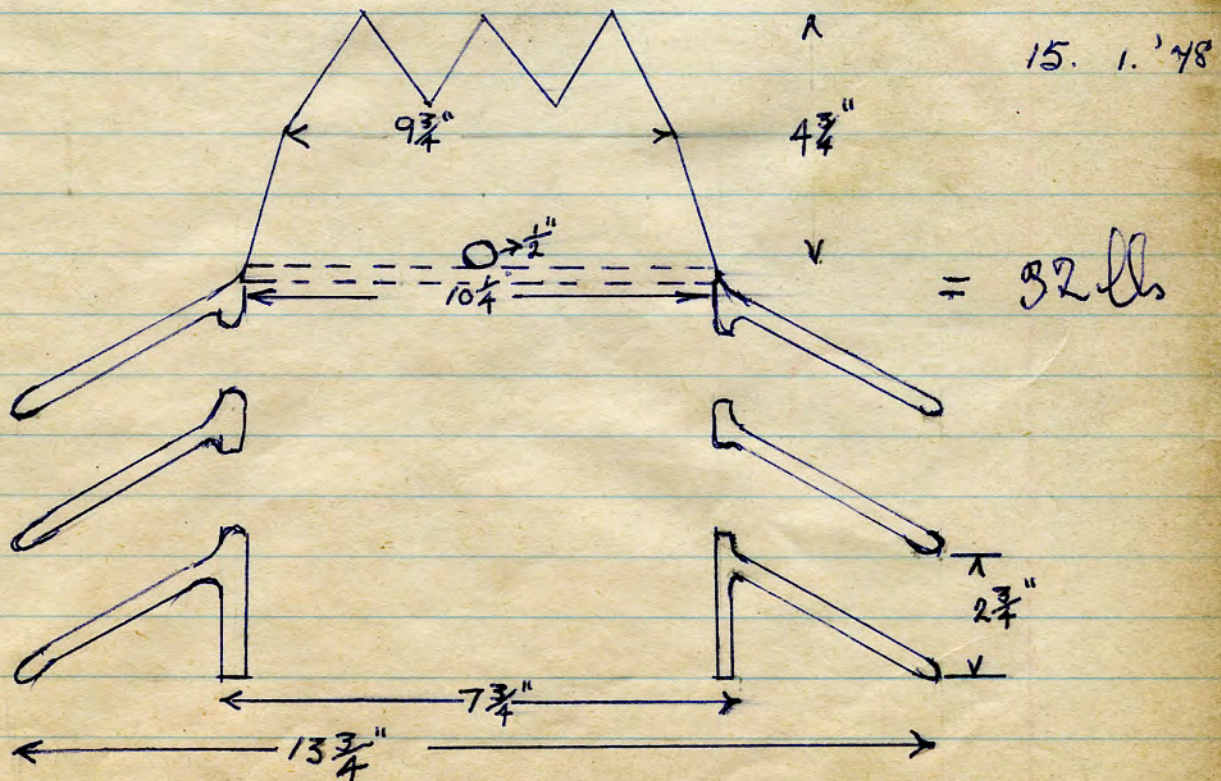
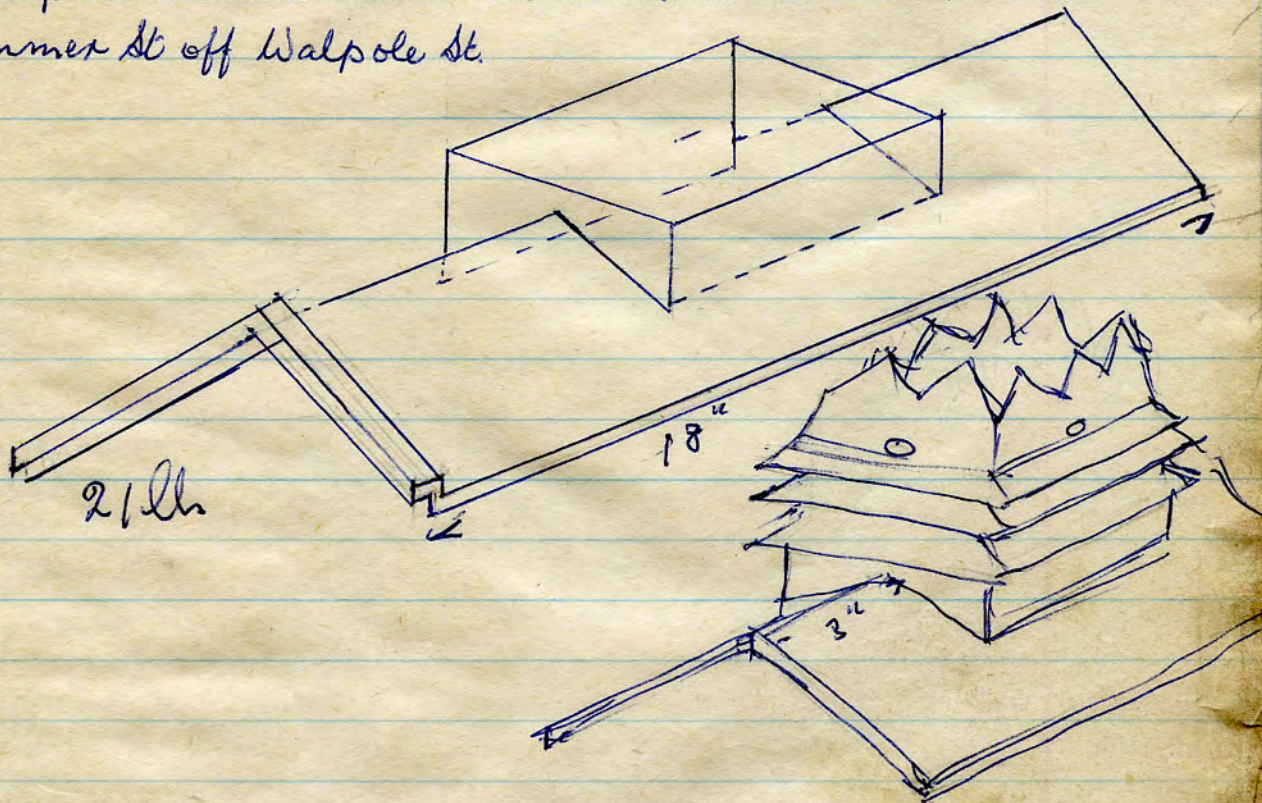

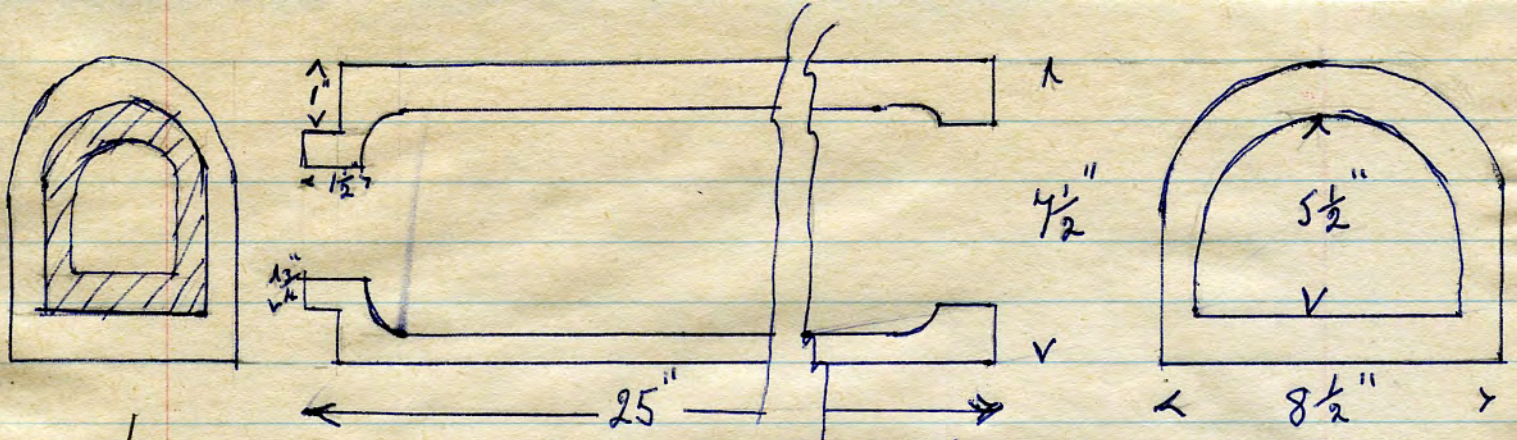

x1032 ✓
x

Capping for back yard dividing walls. (9" bricks).
Duckett - Burnley.

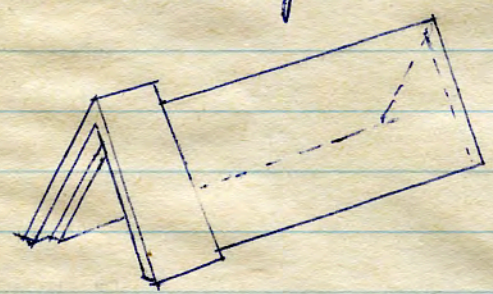

Stamped.
DENIS RUABON

1033 ✓
x

x1034 ✓
x

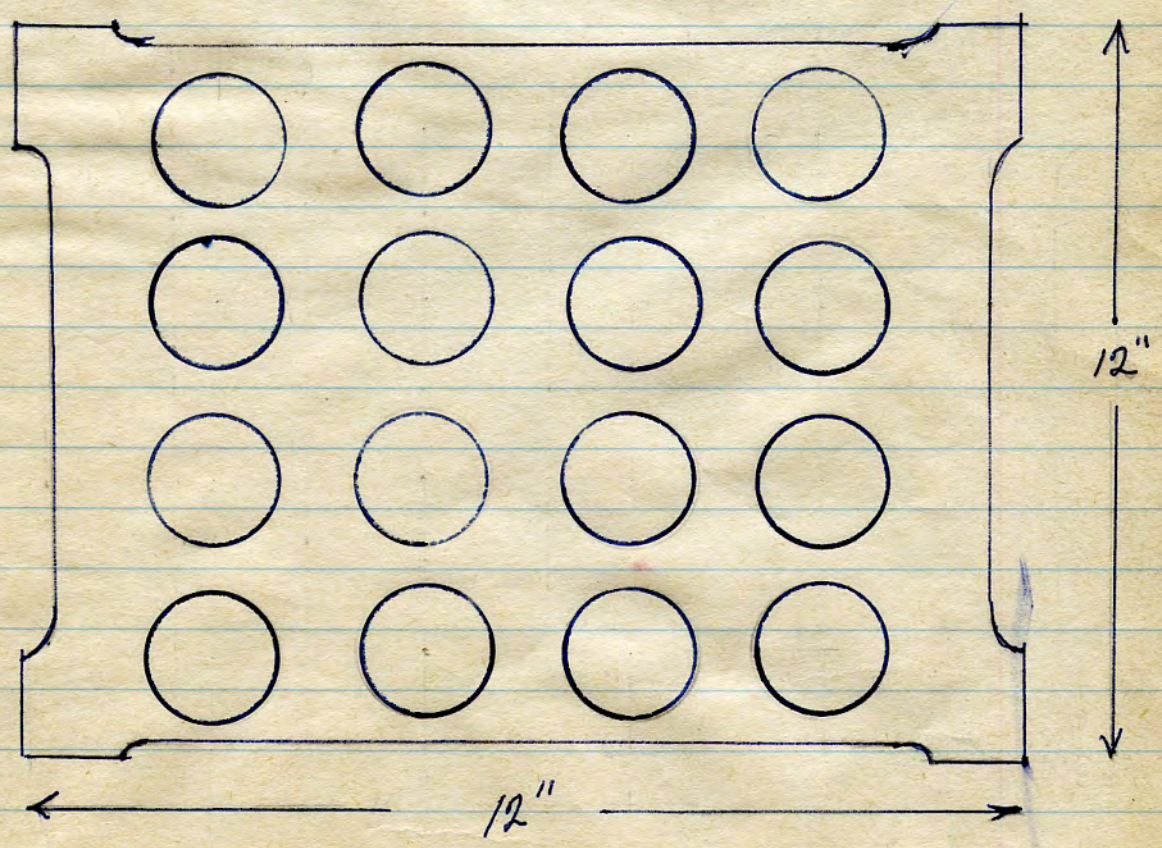

29. 3. '48

PLATT ENGLAND FERROWITE.

✓
1004 x red floor tile 6" x 6" x 3/4"
(Hapton Wood)

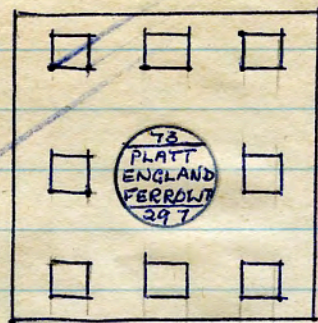

✓
1005 x Vent box. no name.
9" x 5 3/4" x 4 3/4" outside
7 1/4" x 4 1/4" x 7 3/4" inside.
(Huskwood Housing Site
Hardman Drive)
modern fire clay.

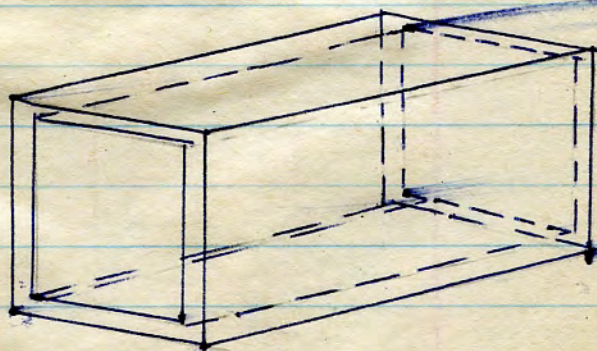

WHEATLEY TRITON MADE IN ENGLAND.

150
✓
1014 x Feather brown tile 6" x 6" x 5/8"
letters in relief. 1 3/4" h.
(R. B. Seville's)

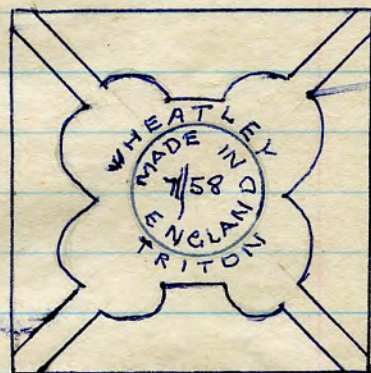

✓
x 1018 Terra cotta channel (nosed)
(Canfield B & T. Co.) no name.

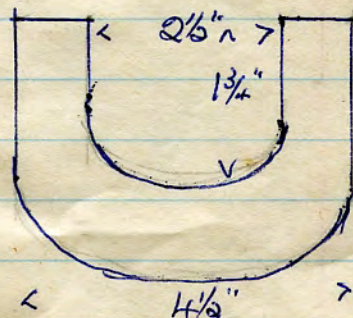

✓
x 1035. Bricks channel. 9" x 4 1/2" x 3"
inside dimensions as 1018 above
square base. no name
(blayton le moors).

1036 x

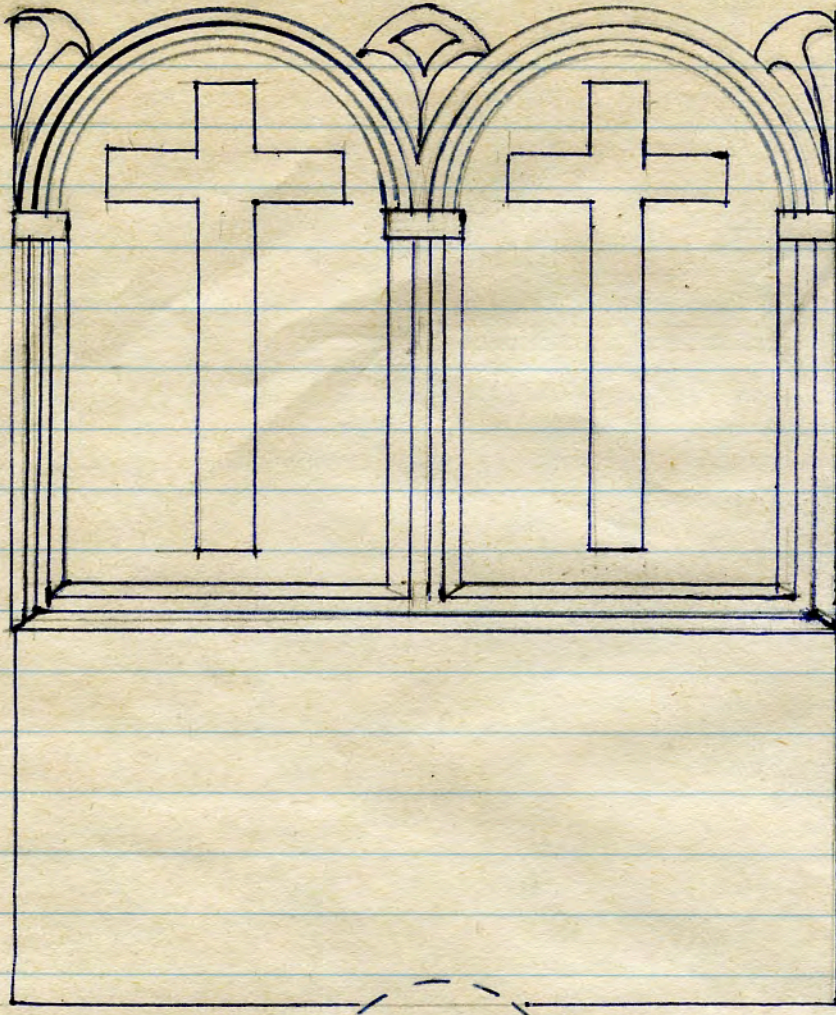

Garden edge tile from St James the less, catholic church, R/stall. Donated by the priest (via S. Spence)

Yellow fire clay no name. 12" x 10" x 3/4" 8 lbs.

x 1037 x

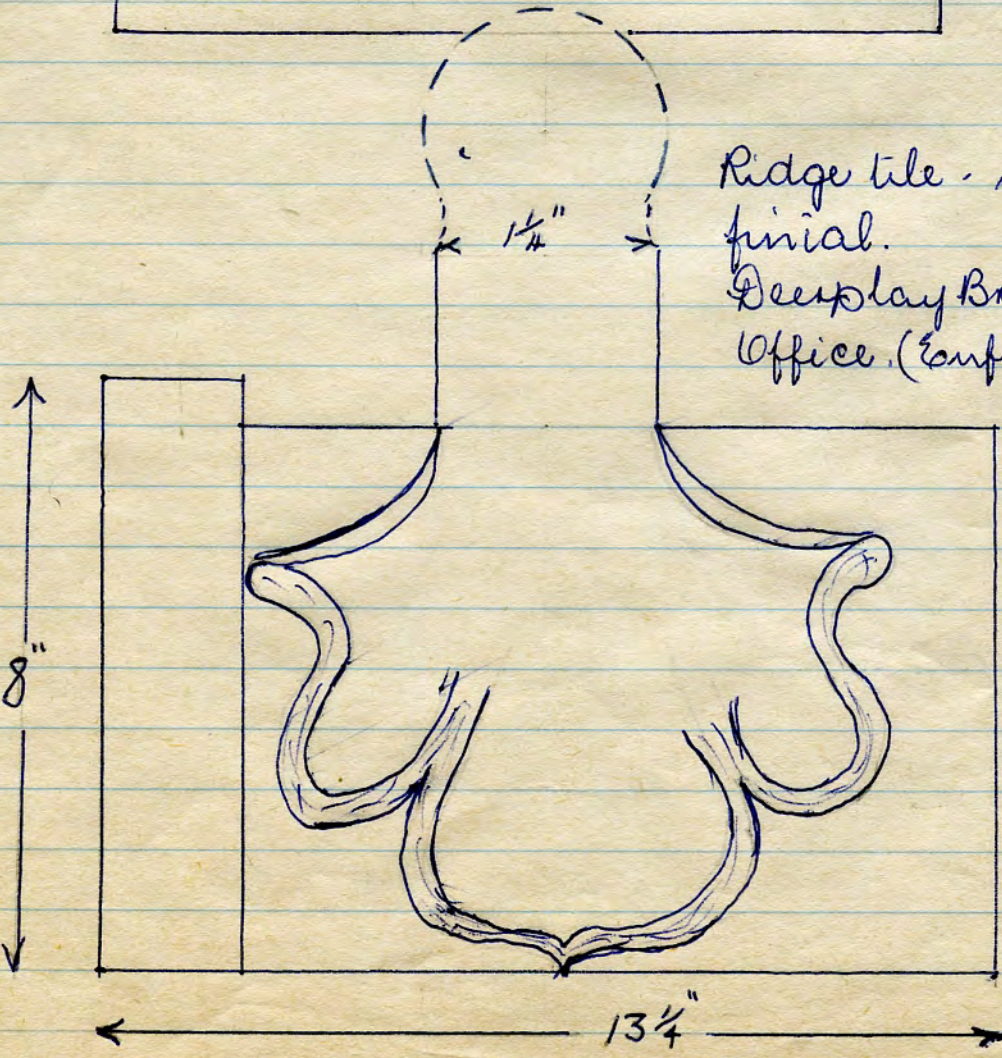

Ridge tile - stop end with finial. Display Brick Works Office (Enfield B & J. Co). 1. 5. '98.

Made Whitaker Blackburn

1038
x x

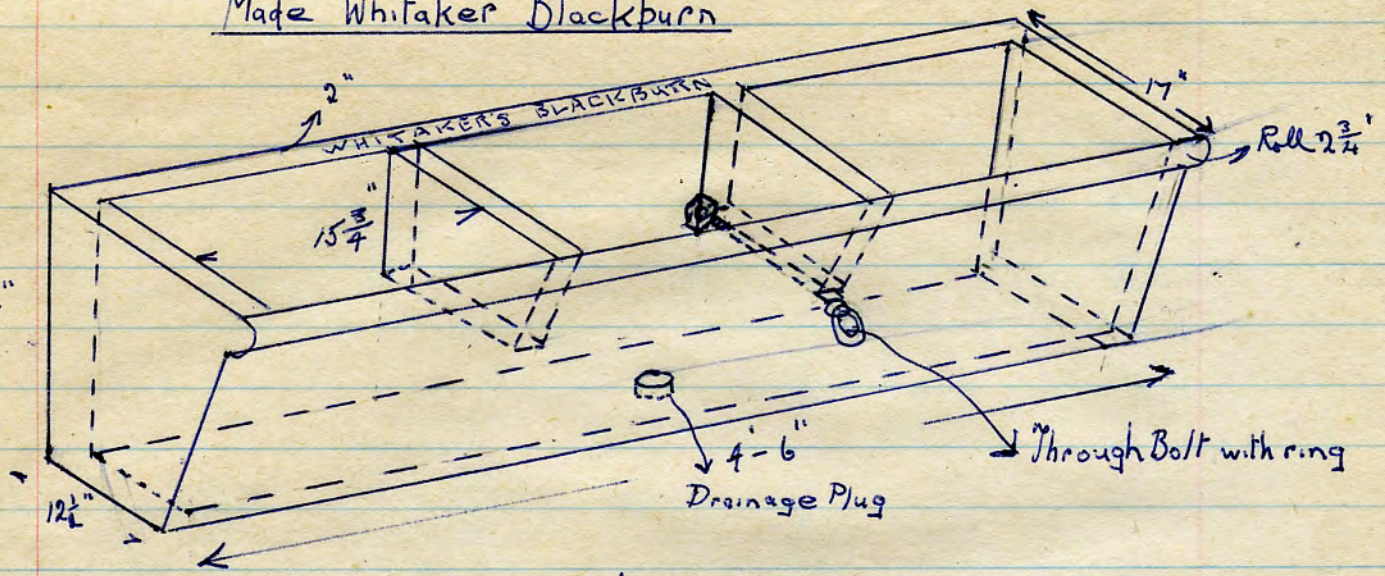

Horse Feeding Manger

1039
x x

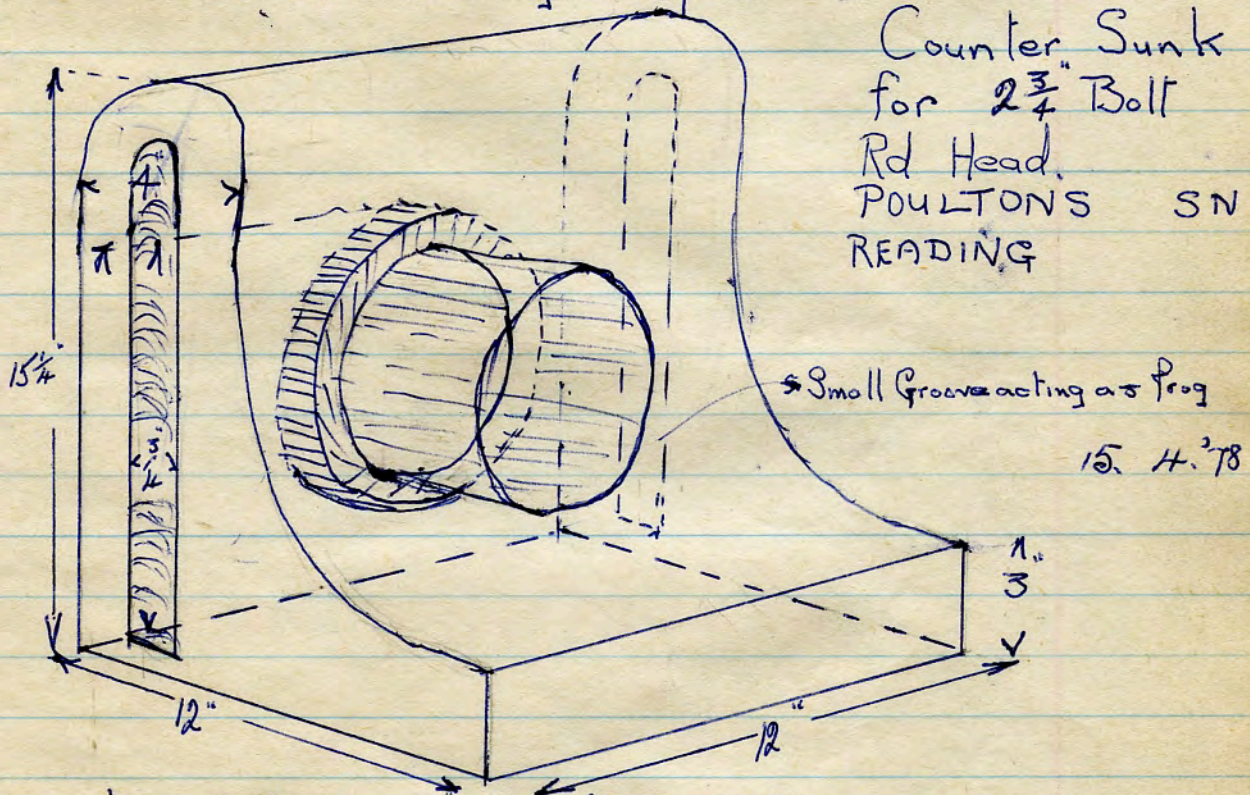

Inwell Springs Printing Co
demolition
fine clay.

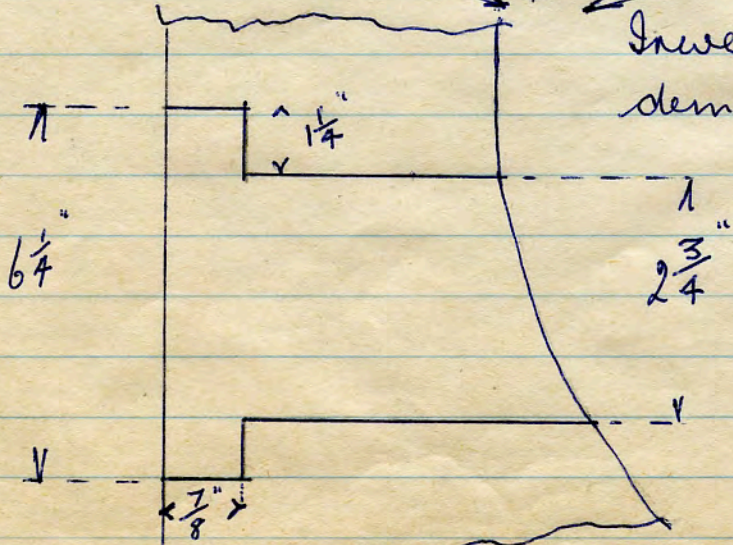

Section through bolt hole.

1040x
x

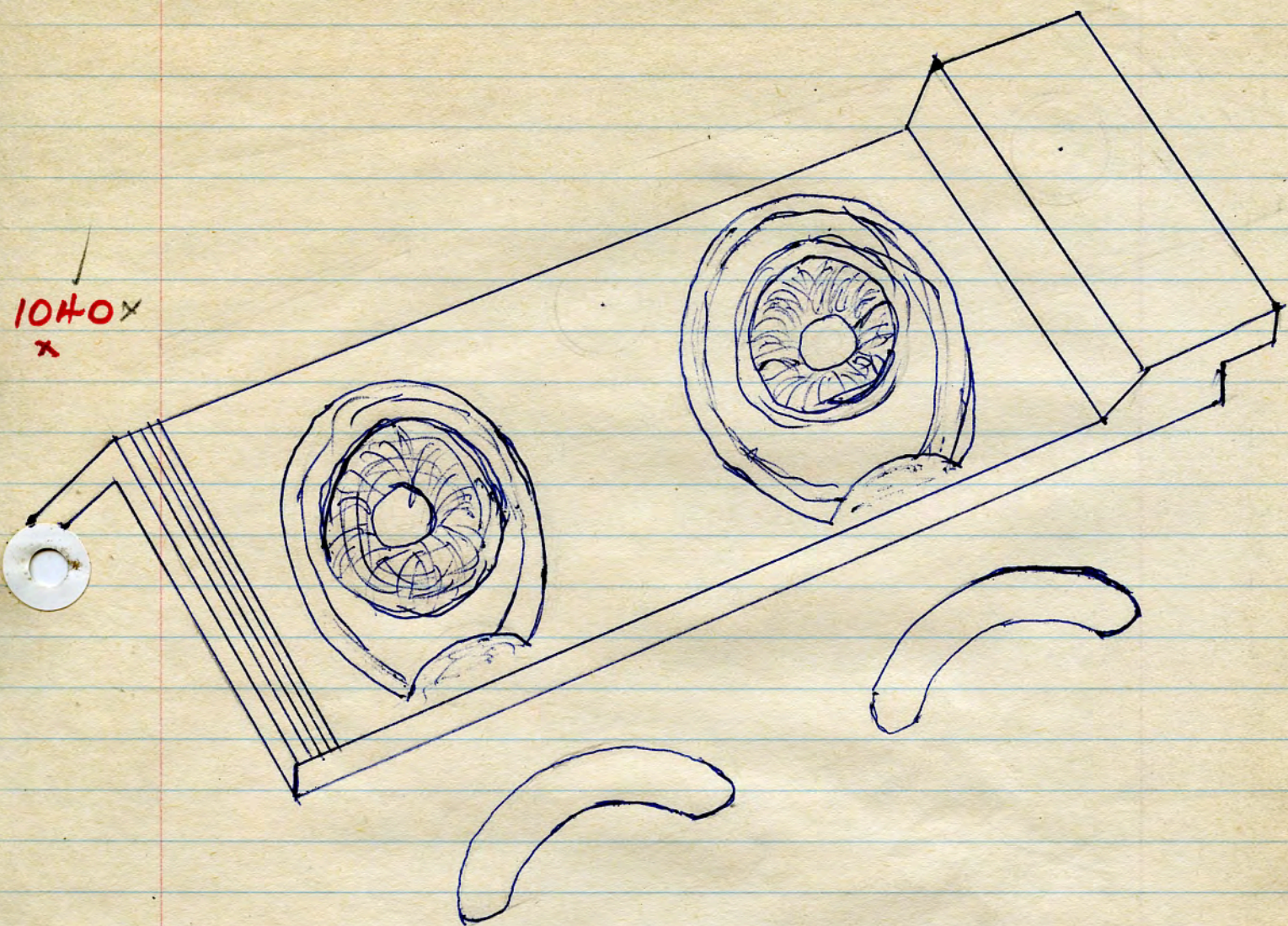

Garden edge tile, rope pattern
 9" x 8 1/2", brown glaze all over.
 no name. (Jewell Springs, Bacup).

1028. x 6 lbs 9" x 8 1/2" x 3/4" 15. H. '78

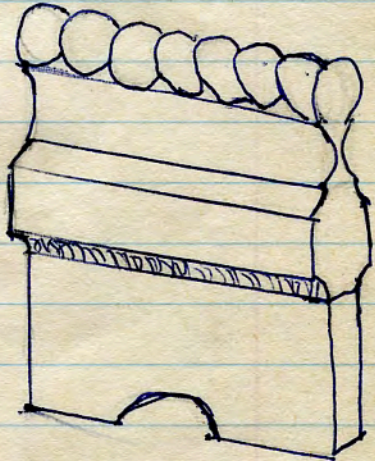

12 lbs.

✓
1041
x x

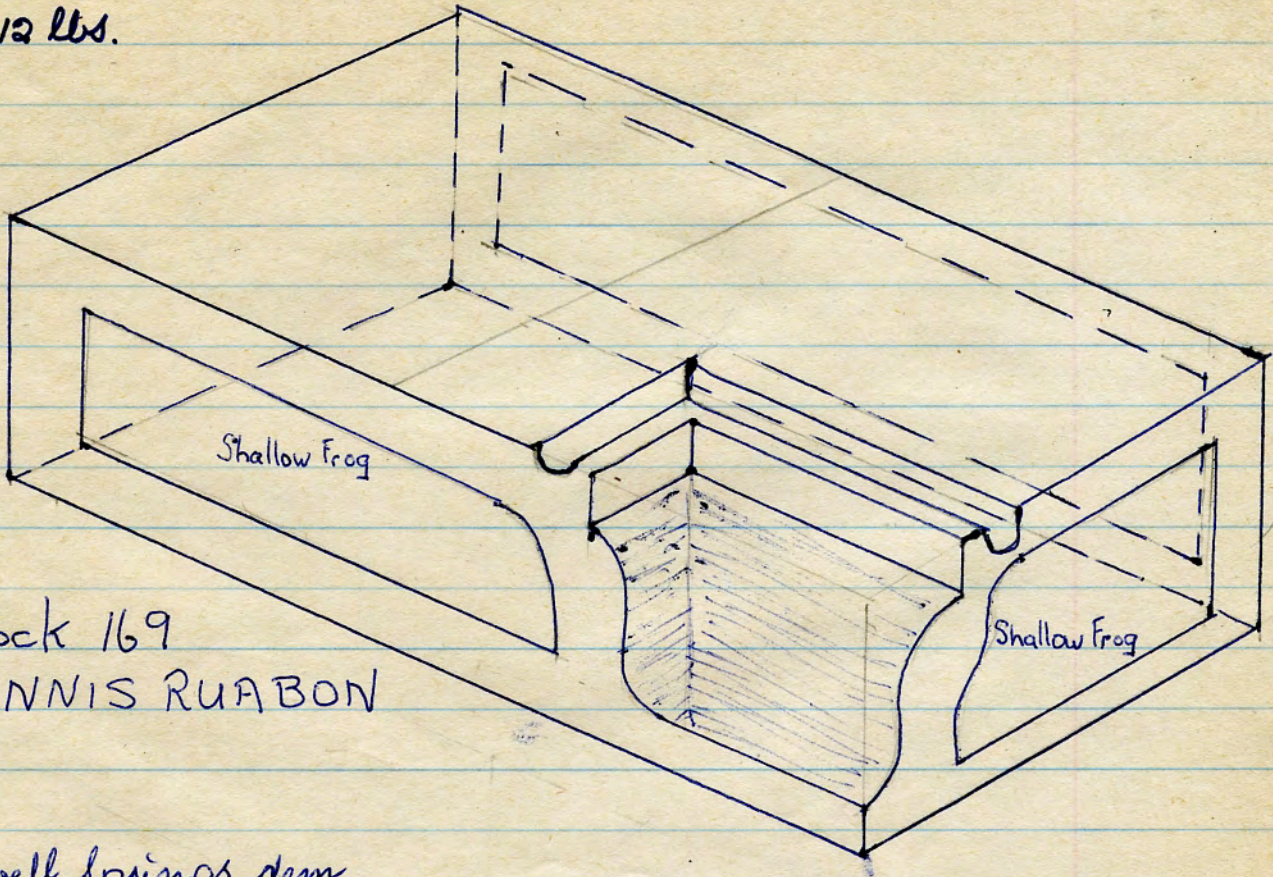

Stock 169
DENNIS RUABON

Juwel Springs dem
15. 4. '78

1042
x x

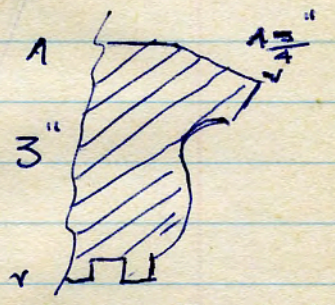
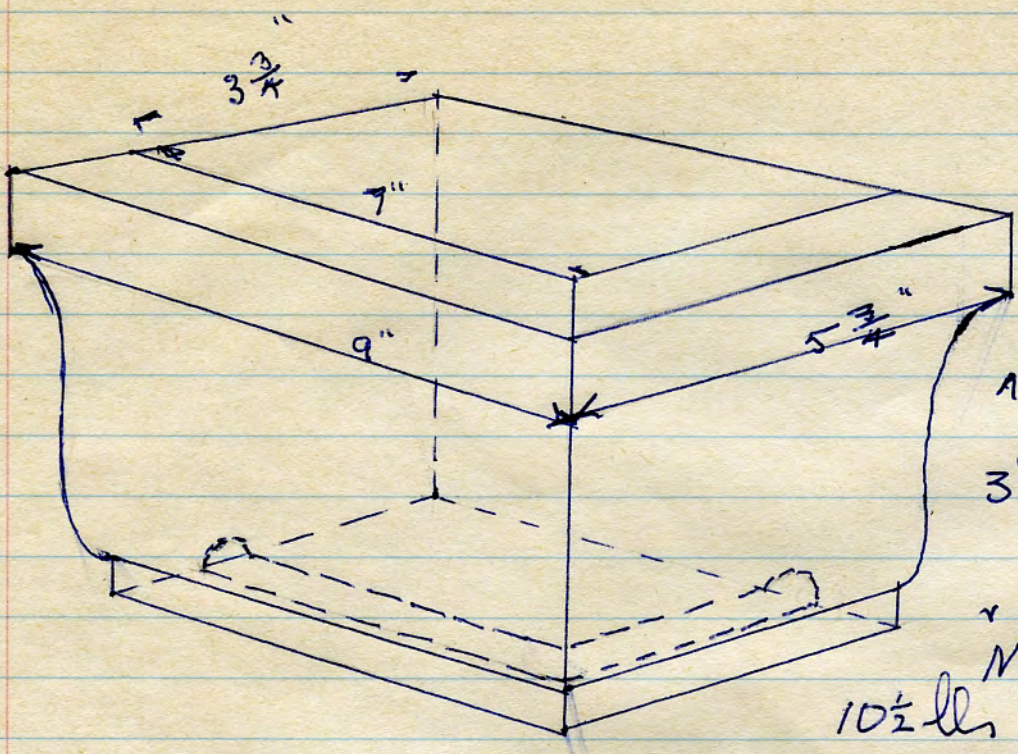

NO 70 Stamped
10 1/2 lbs

1043 x
x

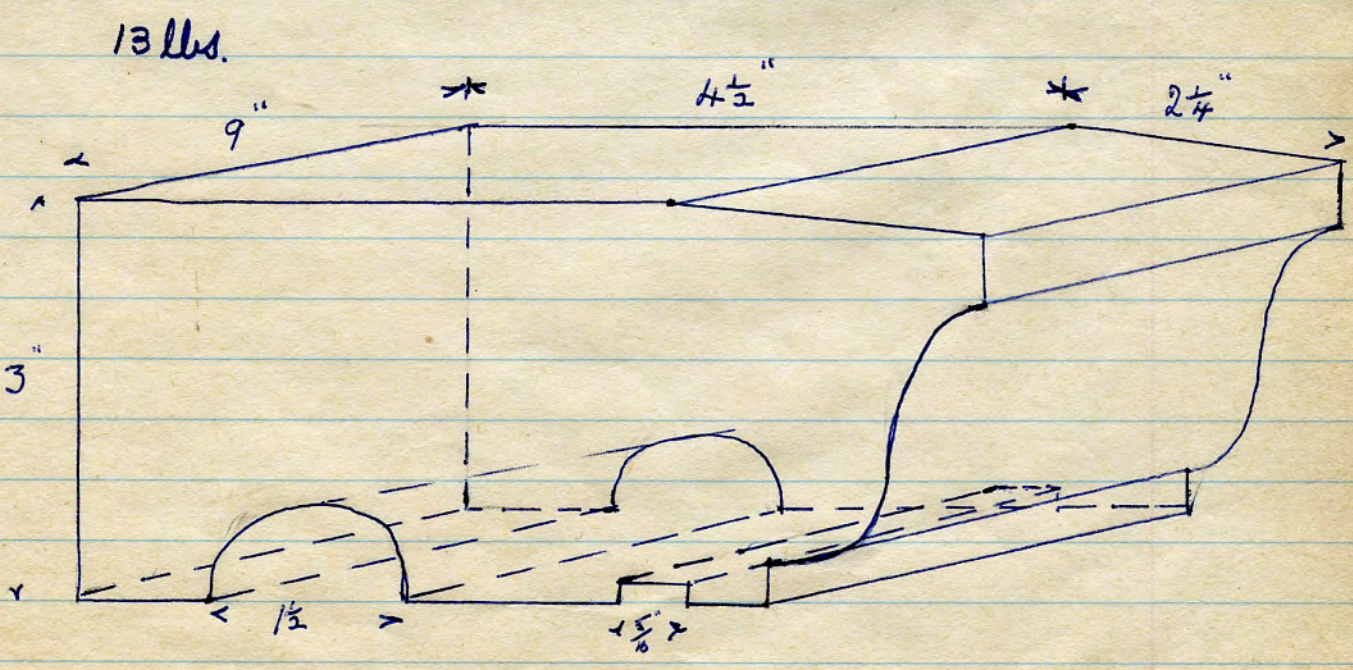

Inwell Springs dem. 15. H. '78

1044x

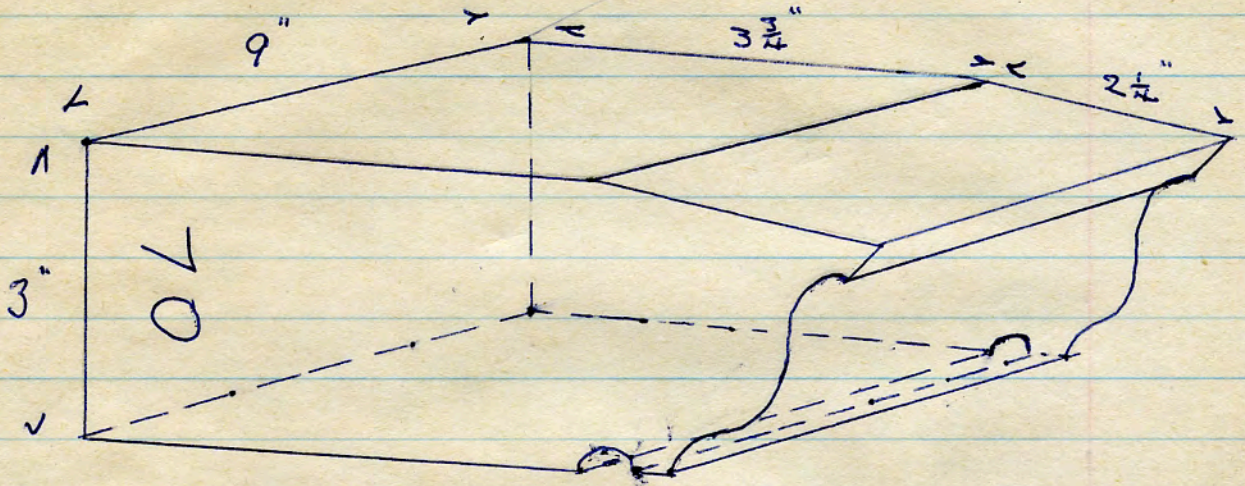

1045x

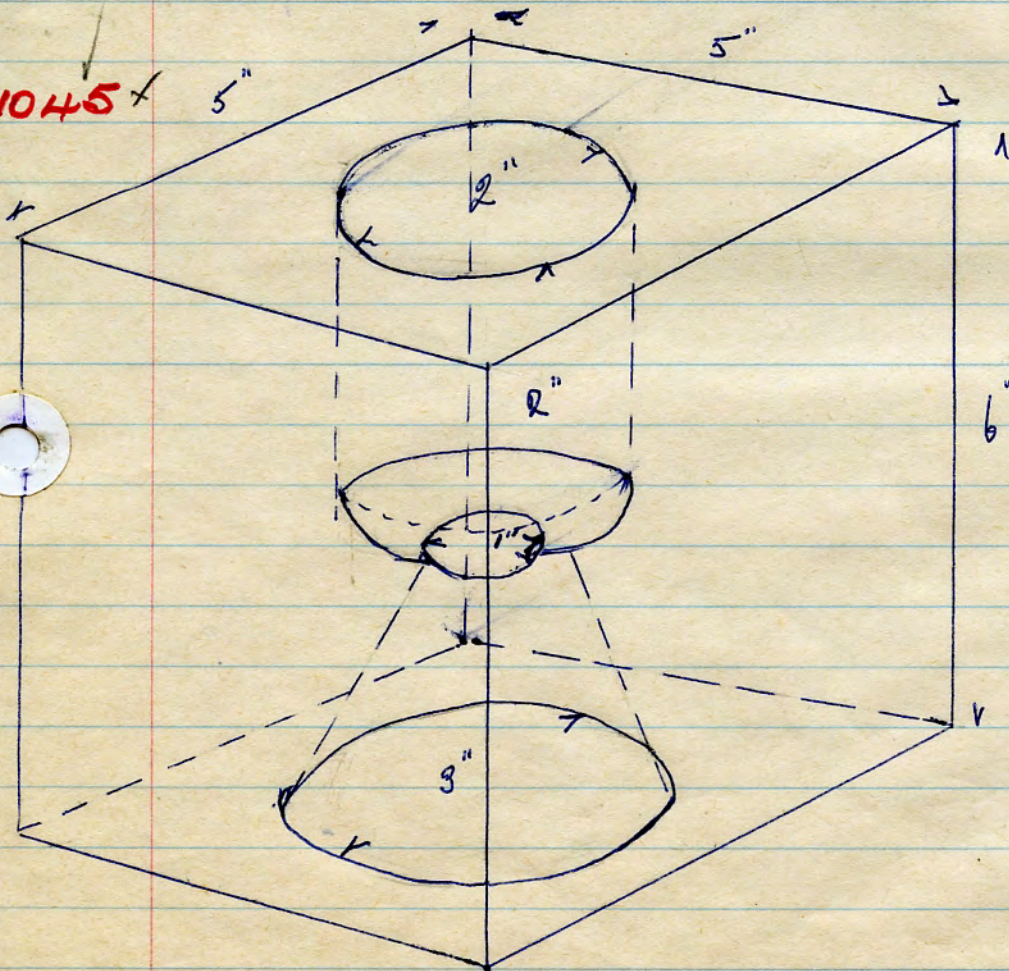

Inwell Springs dem. 15. H. '78

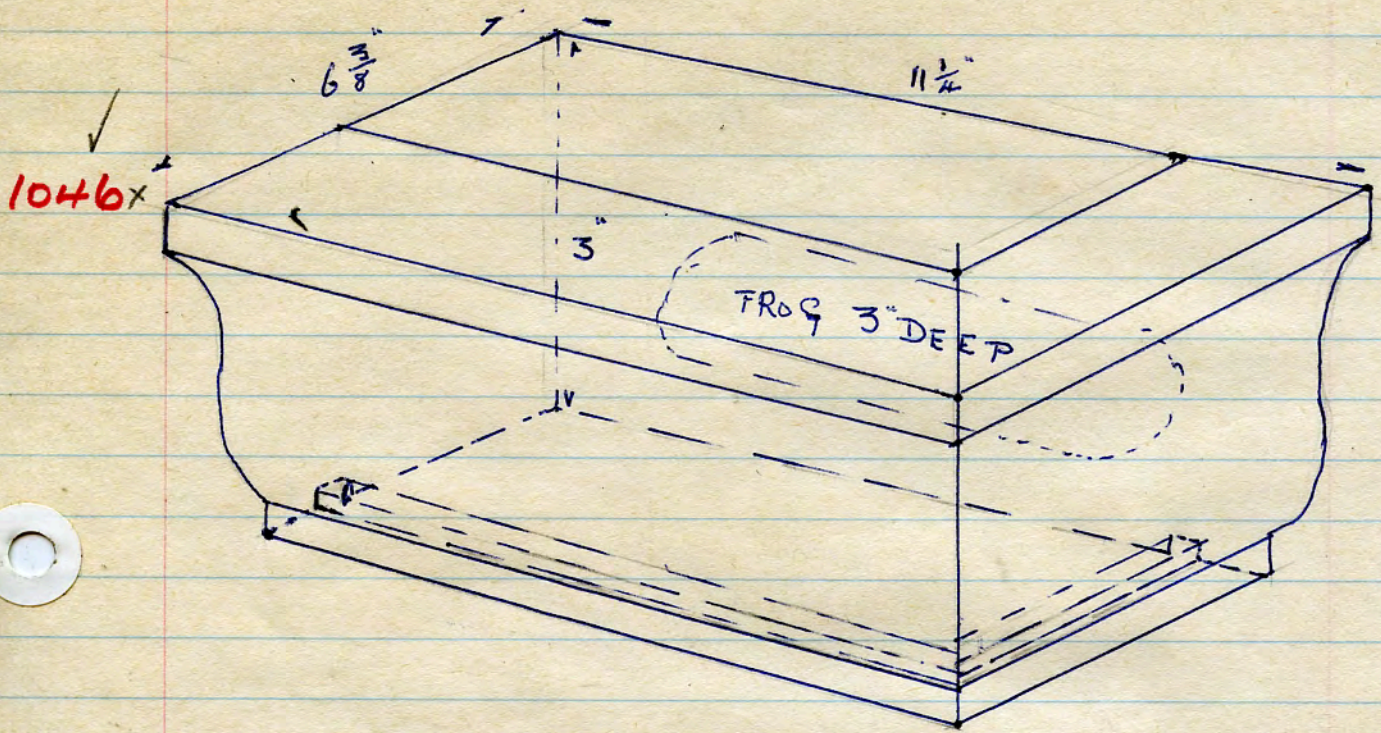

1046x

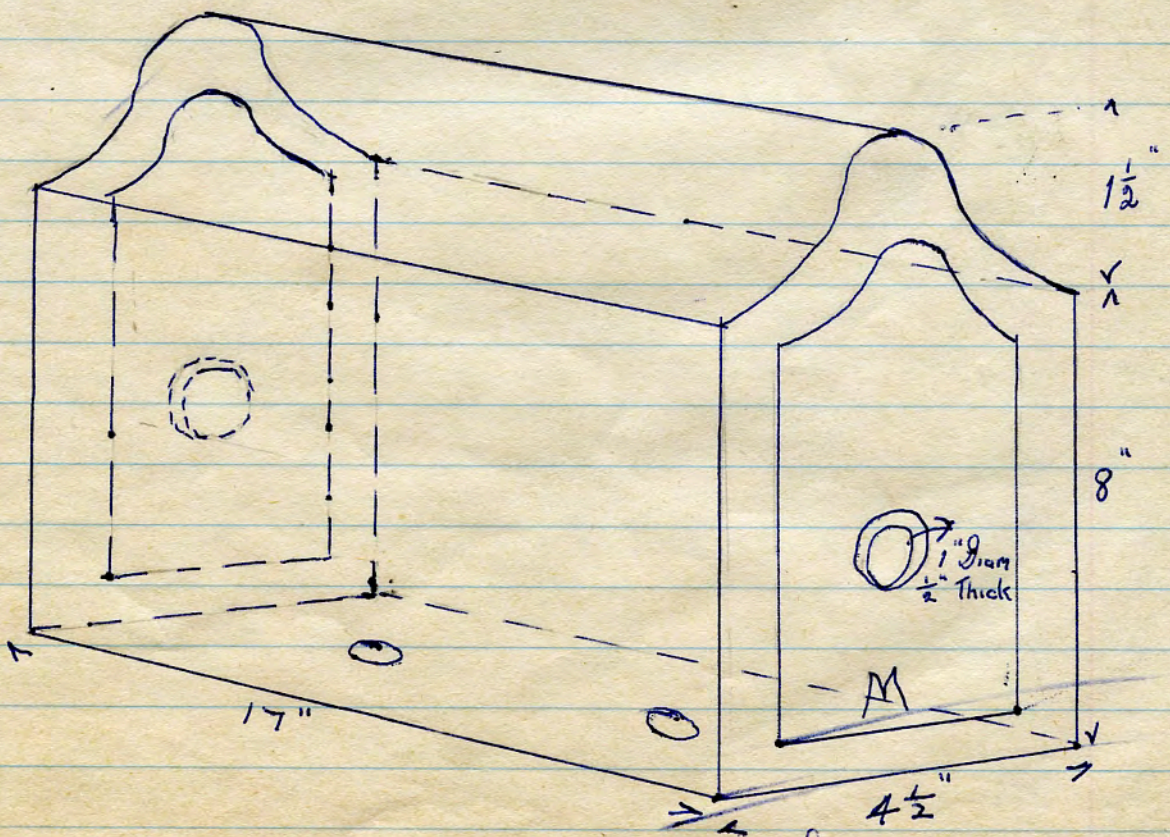

1100x

Inwell Springs dem 15. 4. '78

26 lbs Glayed Brown

1101 x

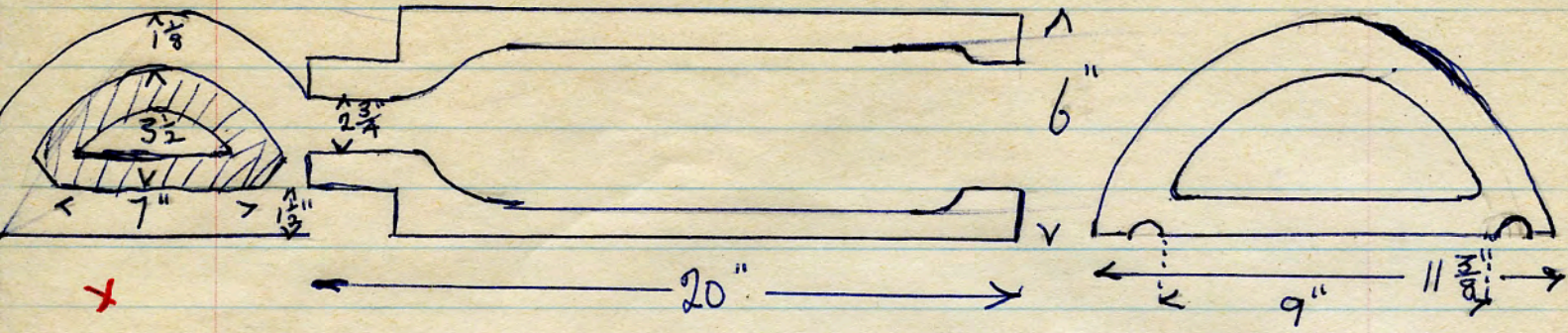

✓
1102
x

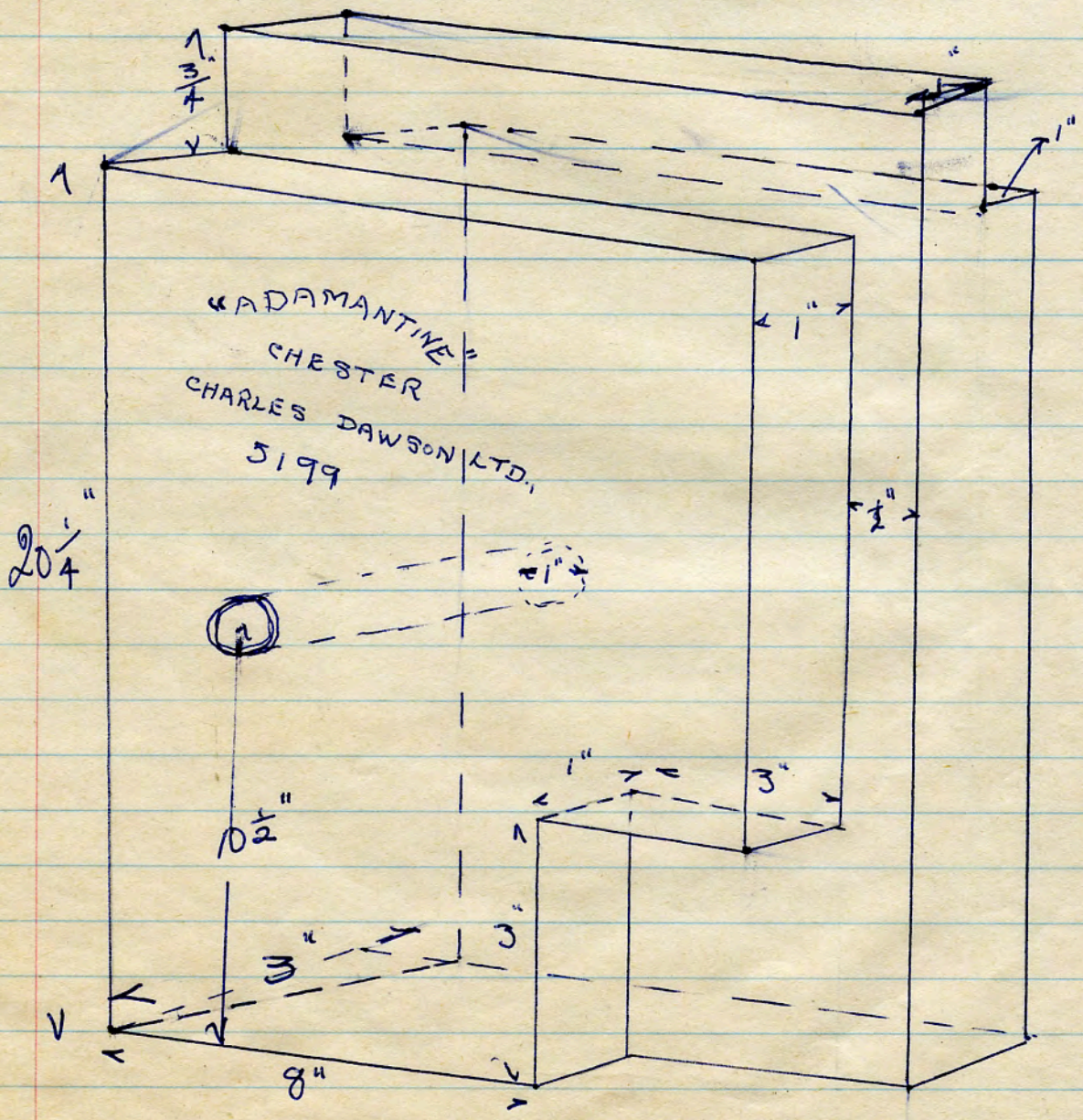

✓
1103

x x

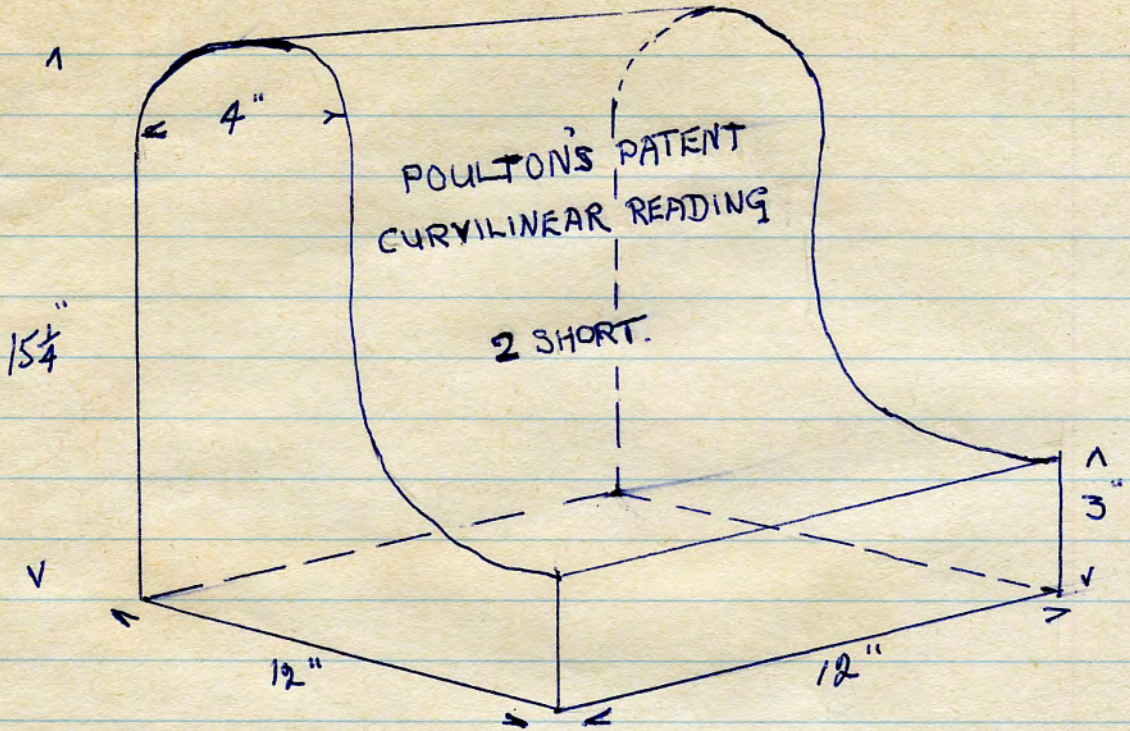

Jwell Springs dem. 15. 4. '78

✓
1104

x

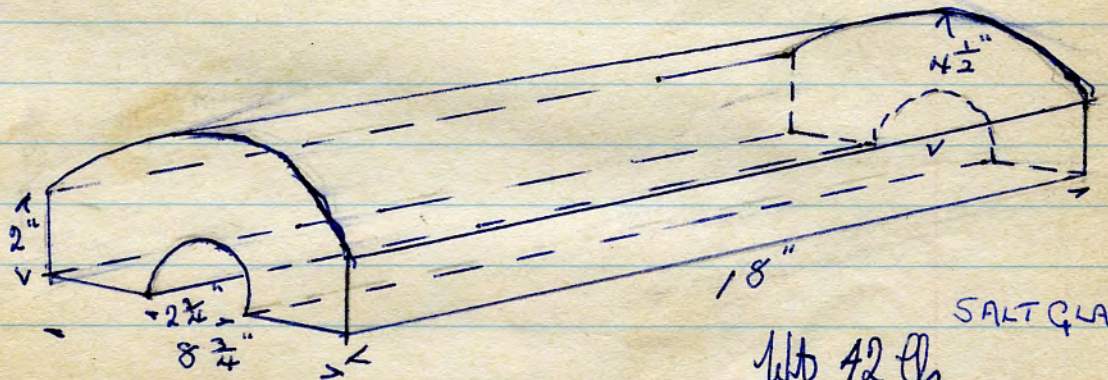

SALT GLAZE

Wt 42 lbs.

✓
1108

x

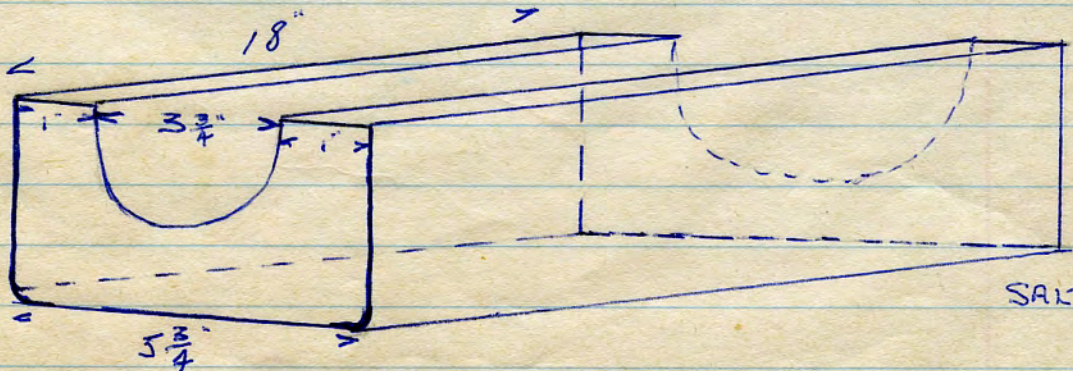

SALT GLAZE



111



1109 ✓
x

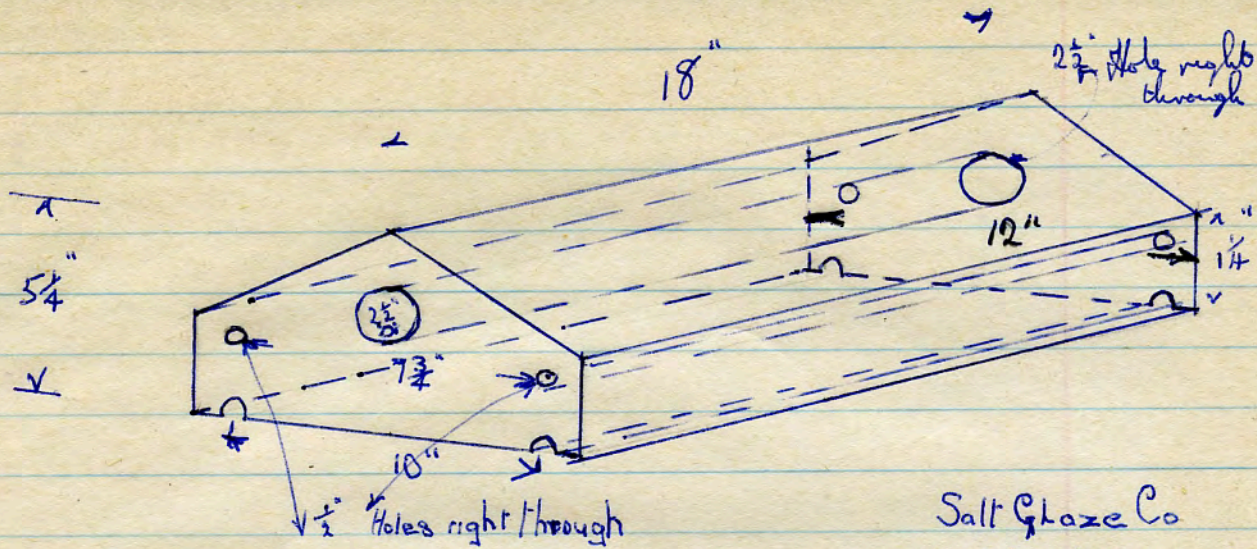

Salt Glaze Co
Ex HAWK MILL
SHAW.



1110 ✓
x

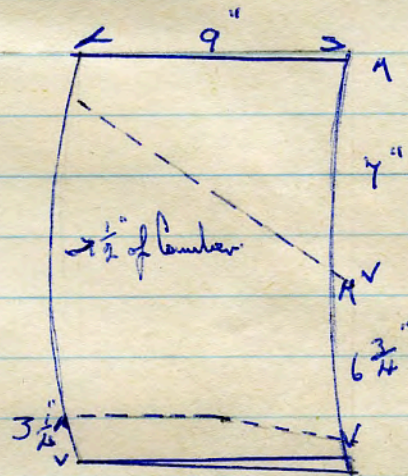
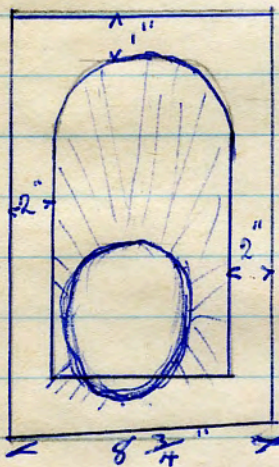

from
Beehive kiln
7" at
Diamond
Bak Co.

CRANKSHAW'S
IXL
SANITARY WARE

Stamped



1111 ✓
x

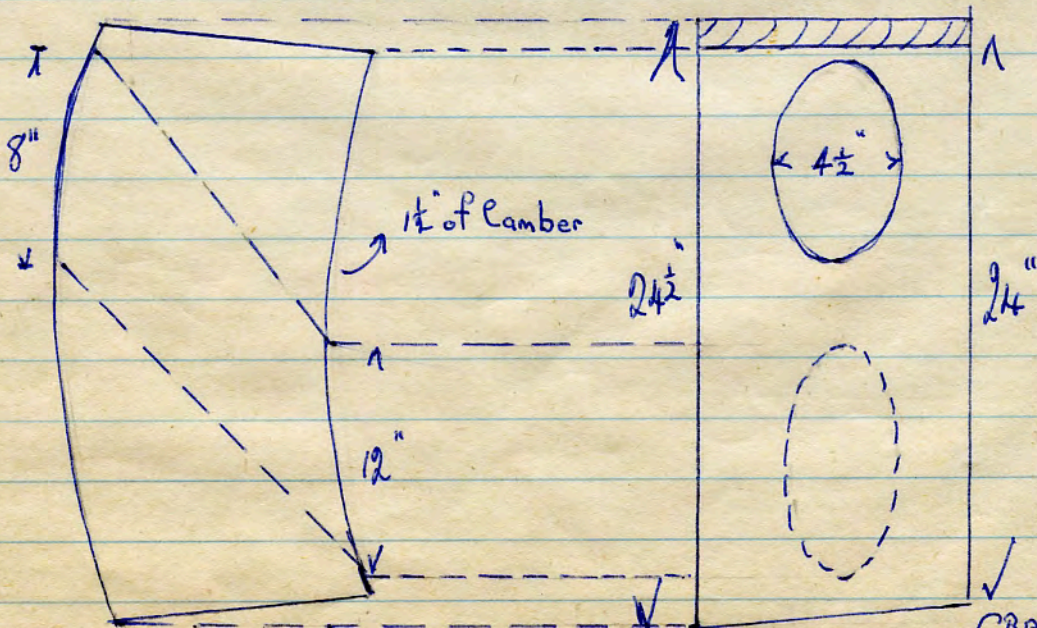

CRANKSHAW'S
HORWICH
LIMITED

Stamped

23. 4. '47

1112 x
x

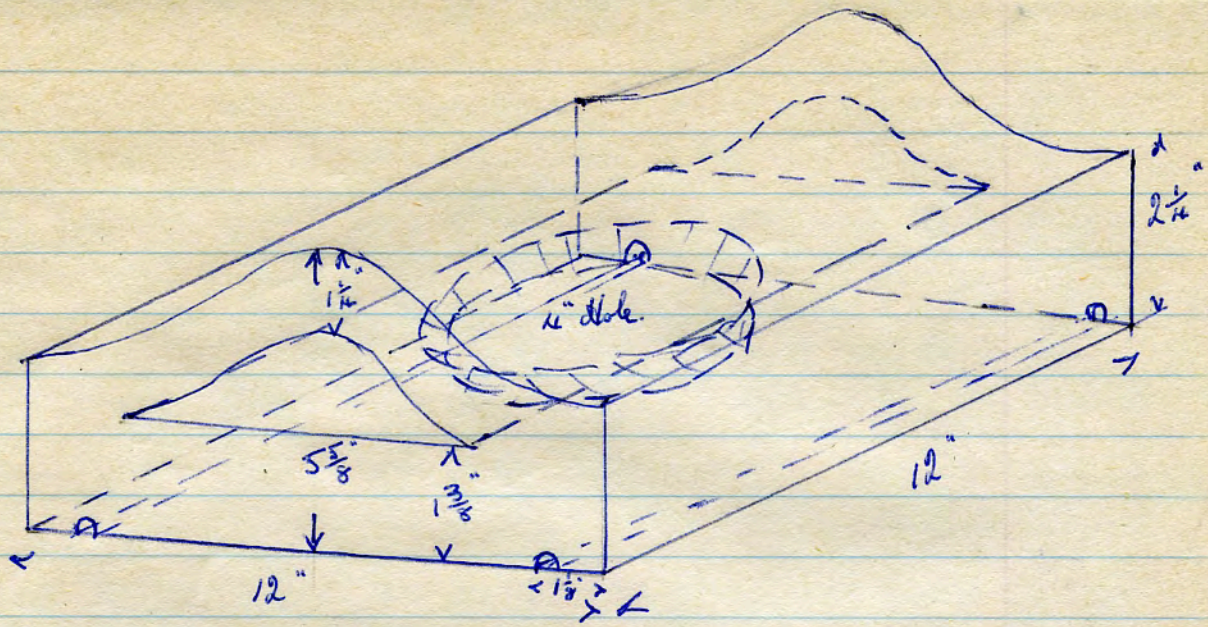

1113 x
x

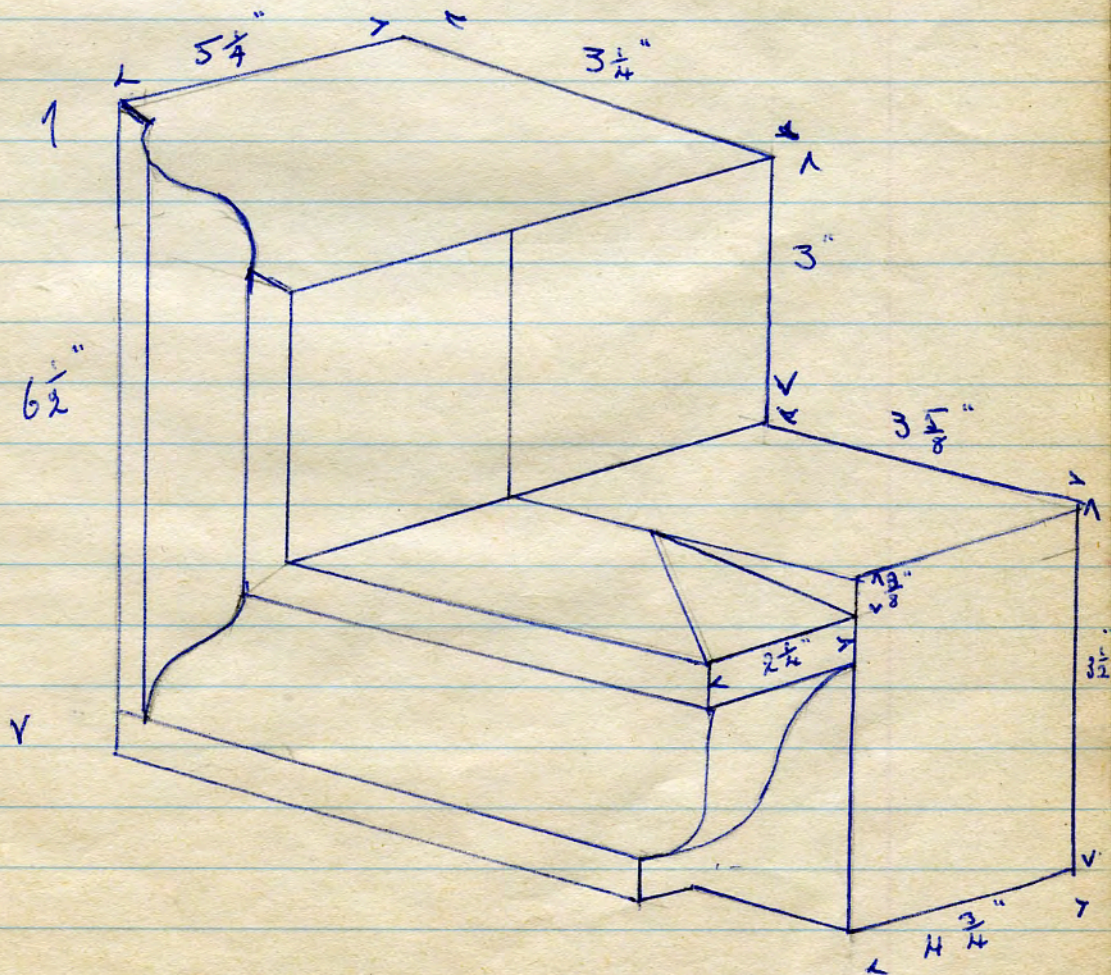

Deerplay Bnk Wks - A. B. & J. Co.
5. 5. 78.

12 lbs.

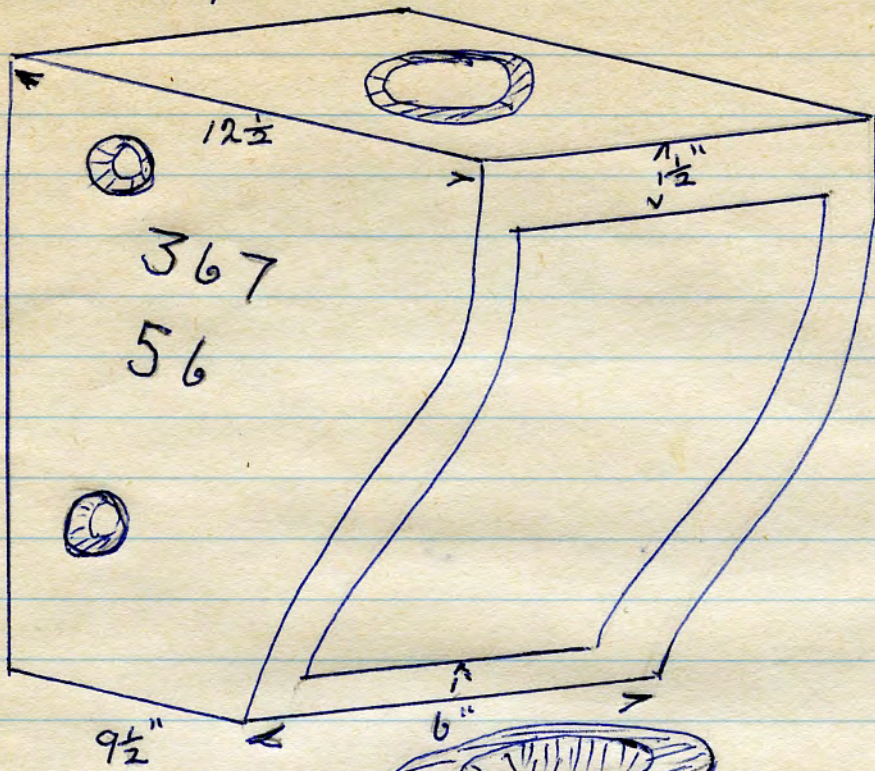

x 1114 ✓

x 1115 ✓
+

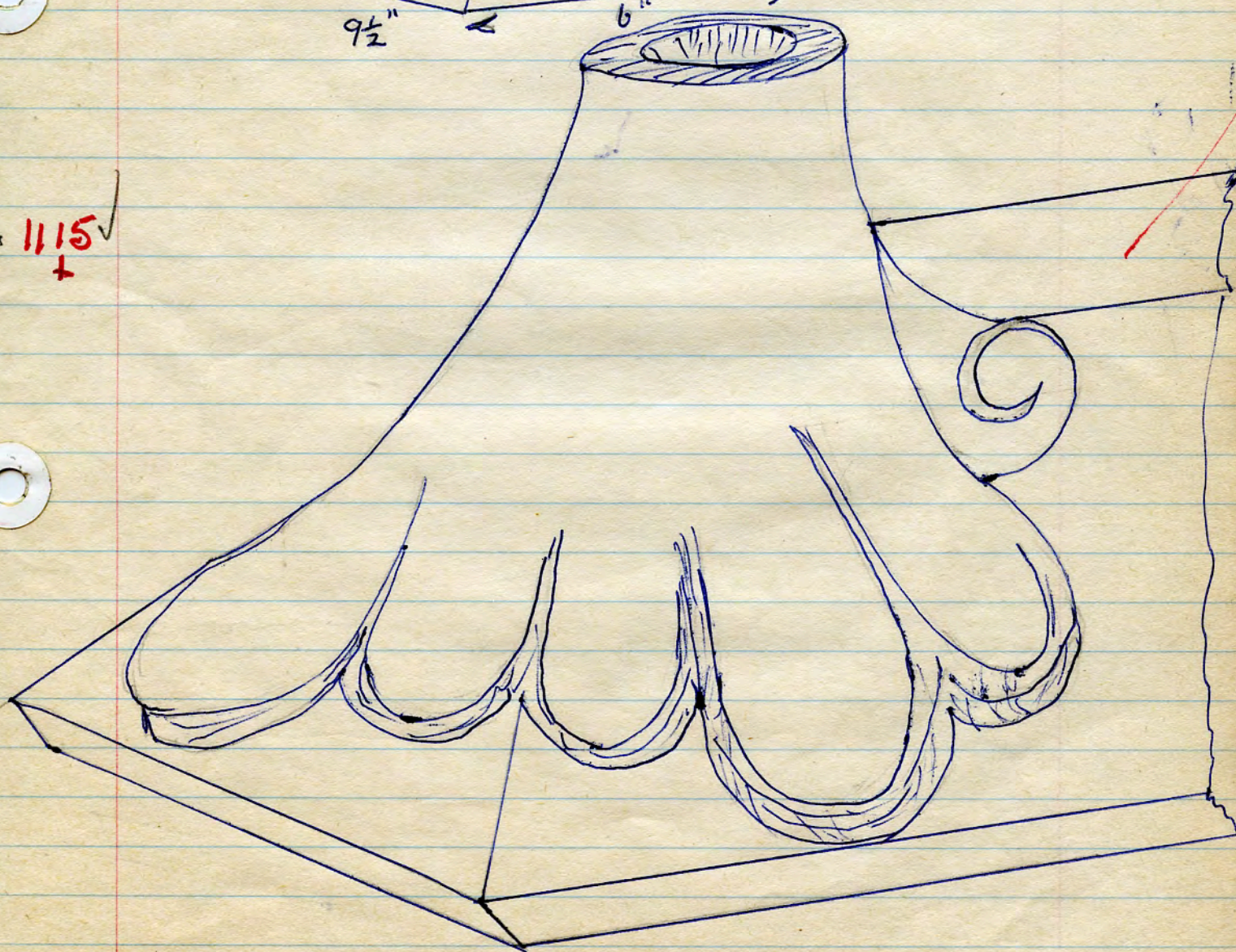

5. 5. '78 Display Bks Wks. A. B + T. Co.

1127 x

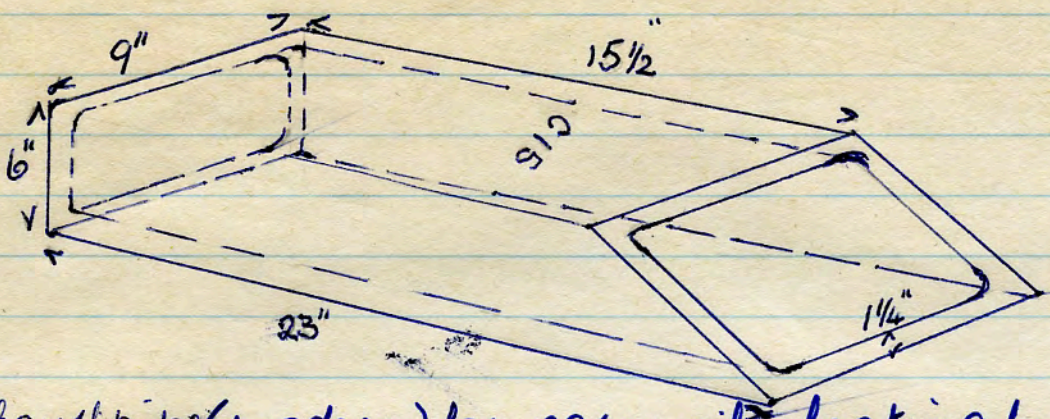

Exhaust pipe (modern) for gas or oil heating boilers



x 1128

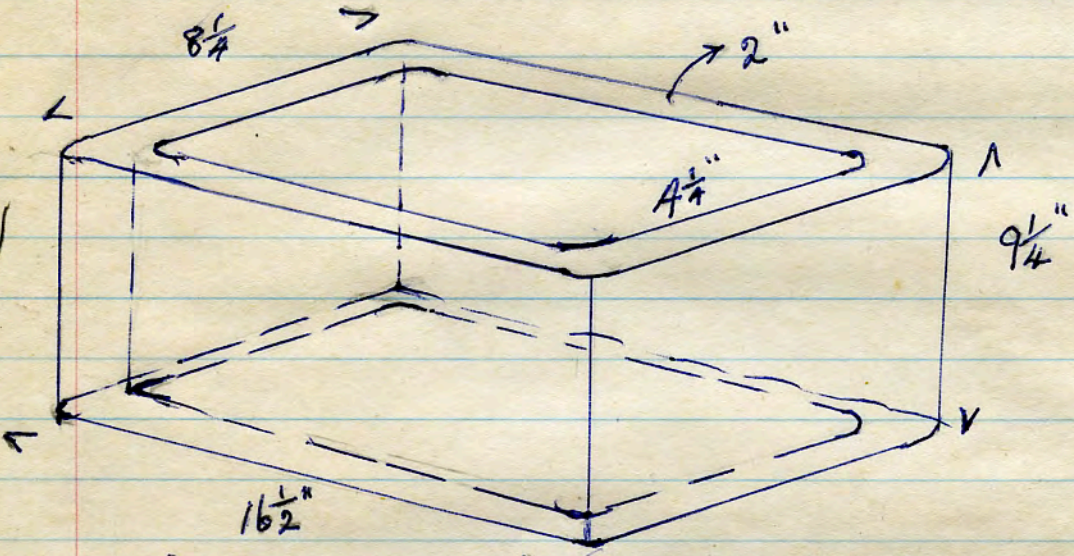

Kiln stand.

(Deerplay Bnk Wks. A. B. T. Co. Ltd)



1131 x

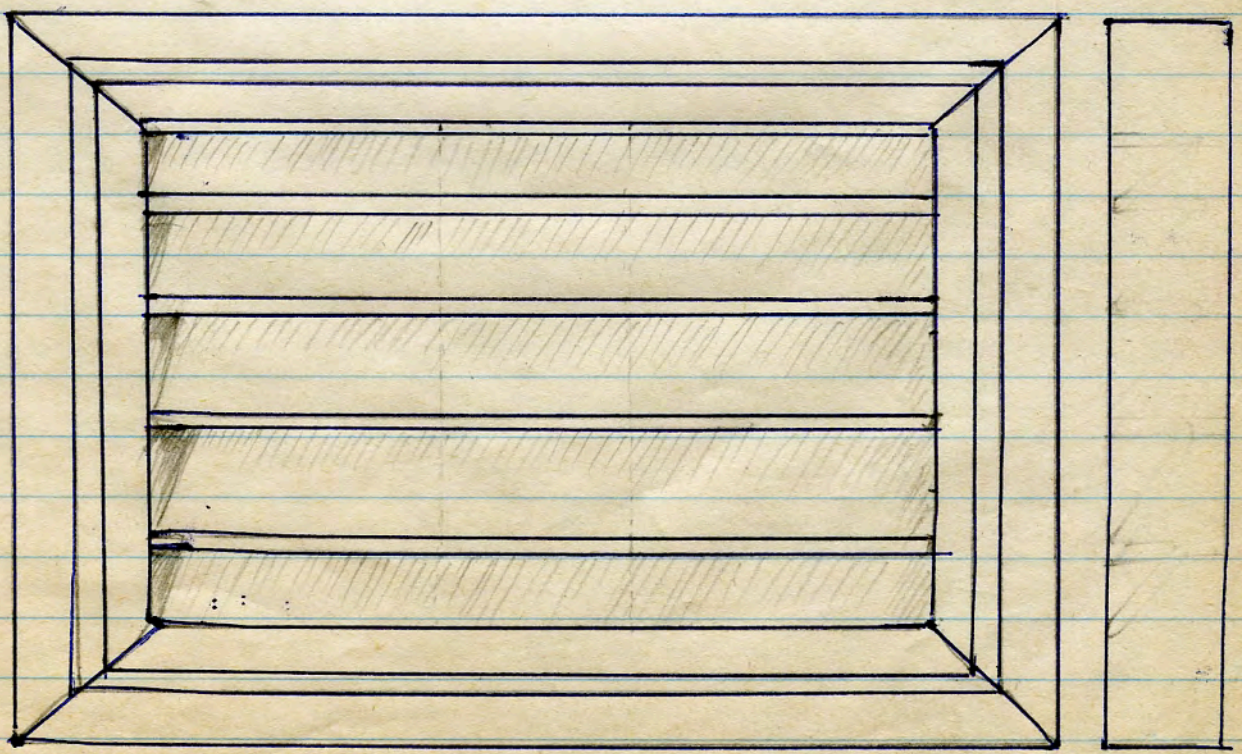

Ventilator brick, no name. 7 lbs 9" x 6 1/4" x 2 3/4"

9"

1132 x
x

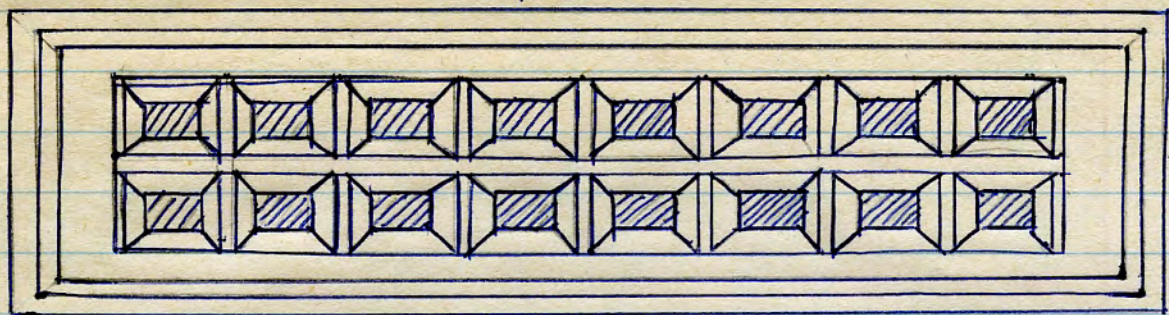

2 1/2" deep
3"

Ventilator - no name. 16 perf/s. 3 1/2 lbs.

x 1138
x

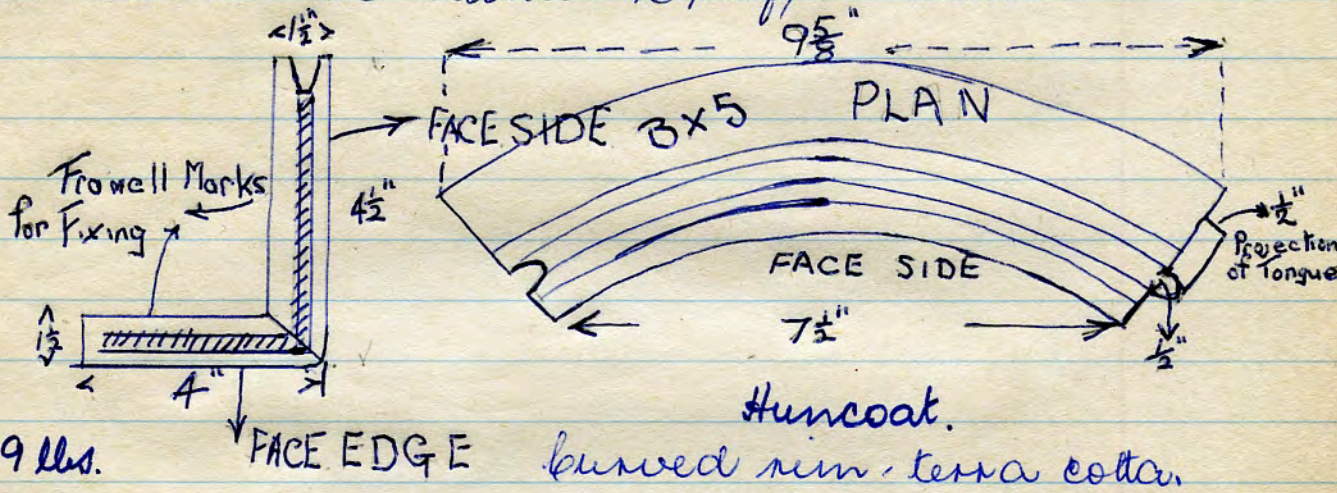

9 lbs.

Huncoat.

curved rim - terra cotta.

28. 7. '78

Mixed return for 9" wall. 12 1/8"

Terra cotta. Deerplay Bk
Wks -
Enfield

x 1139
x

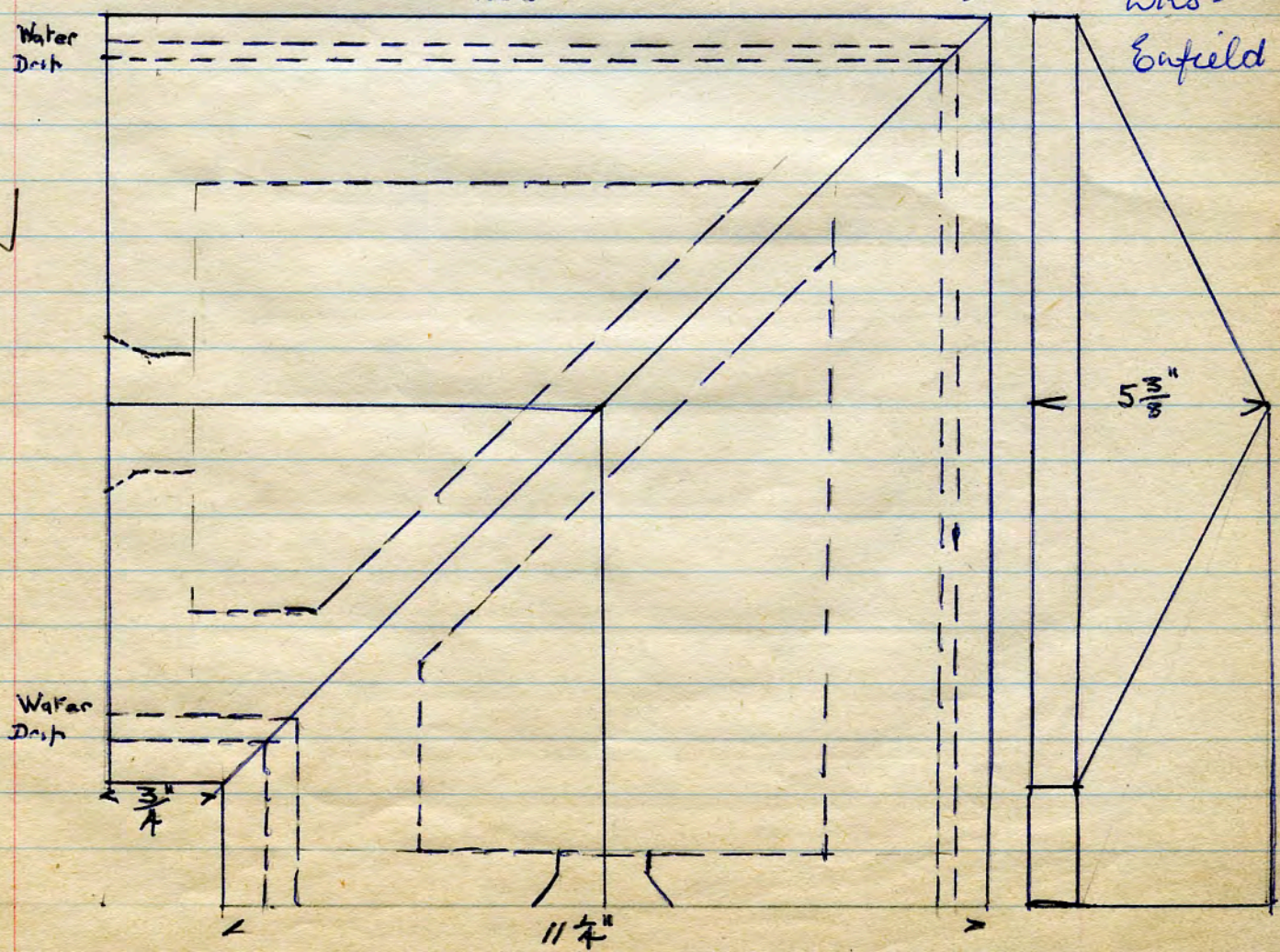

Floor tile - 9" x 9" x 1/2"

1144 x no name. blue, fluted for fixing (Liverpool - Edge Hill)

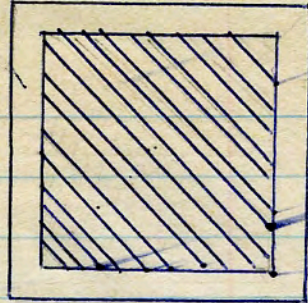

GREENGATE ST HELENS

x 1145 floor tile 9" x 9" x 1/2" 9 lbs yellow, letters incised. (Edge Hill)



1146 floor tile. 6" x 6" x 7/8" 3 lbs blue (Liverpool - Edge Hill) no name TRITON MADE IN ENGLAND 9 4 55



x 1147 9" x

Ornamental Terra cotta - boss 12"

Display. 6. 8. '78

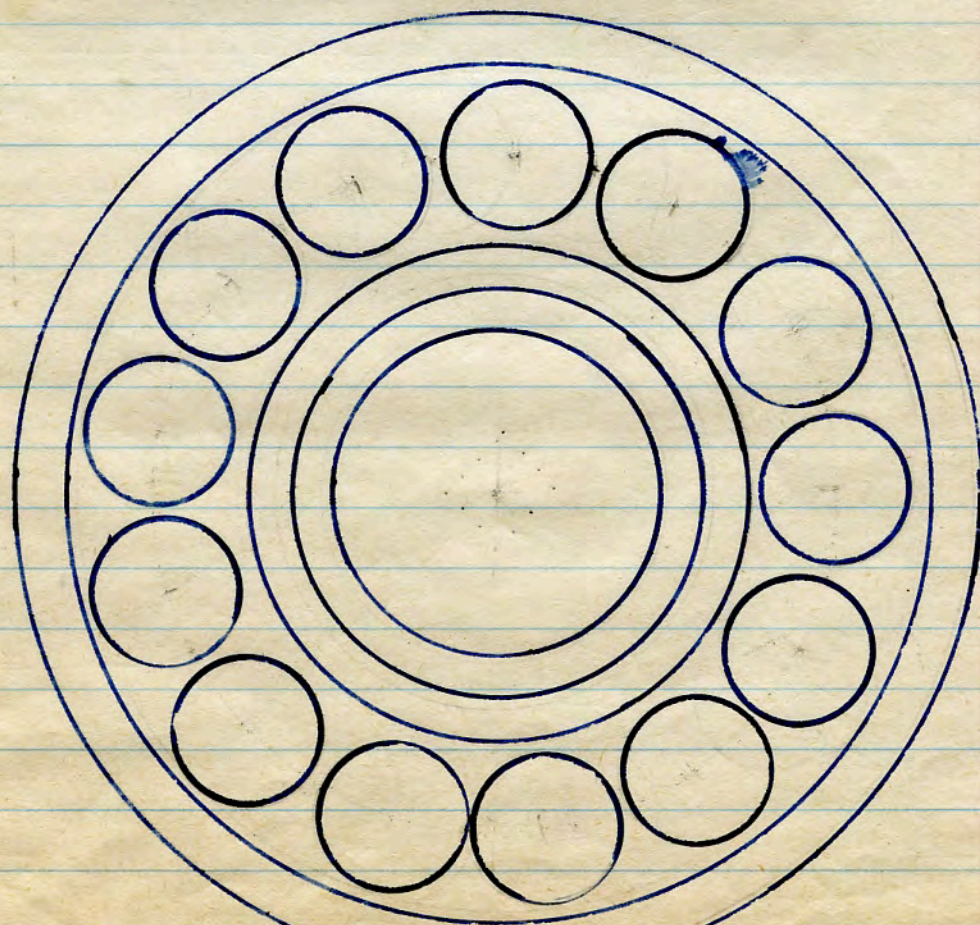
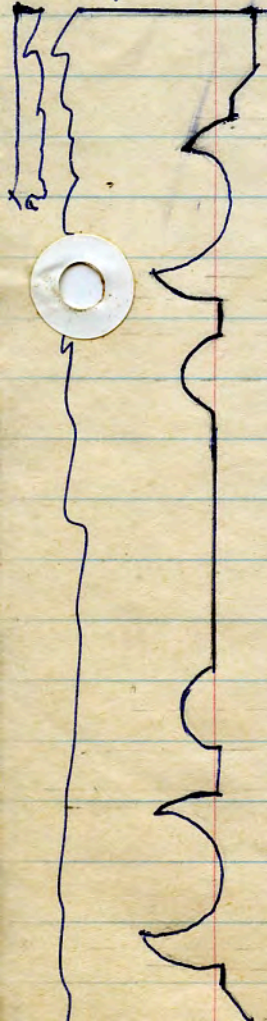

12"

G O I red. dec gauged.

13 lbs. 9" x 5³/₄" x 3" - 2⁵/₈.

Stamped 1 side, 1 perf 2" x 1¹/₂"

1178 Lees St long. Chapel dem, Ogden Lane
off Ashton Old Rd. 21. 2. 82.

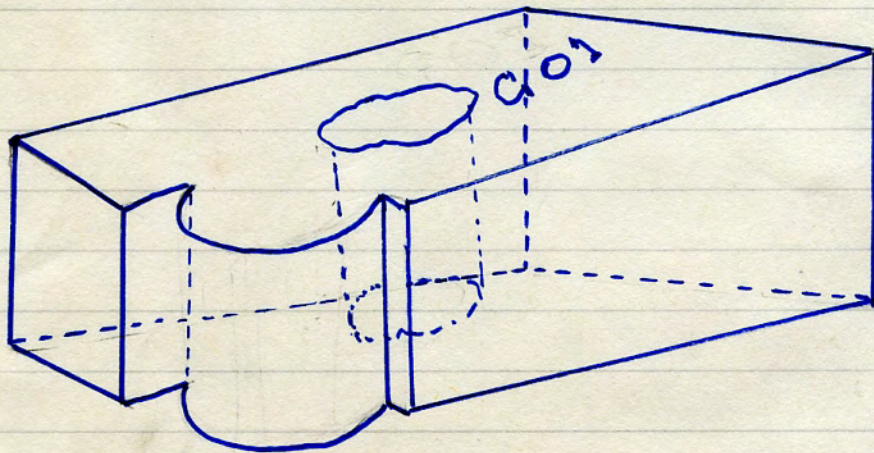

STIFF'S PATENT BIRMINGHAM

1164

(Deerplay Brick Wks). water drain-carrier 5. 5. '78

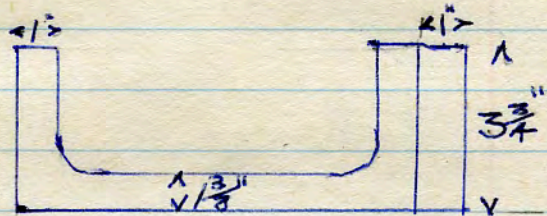
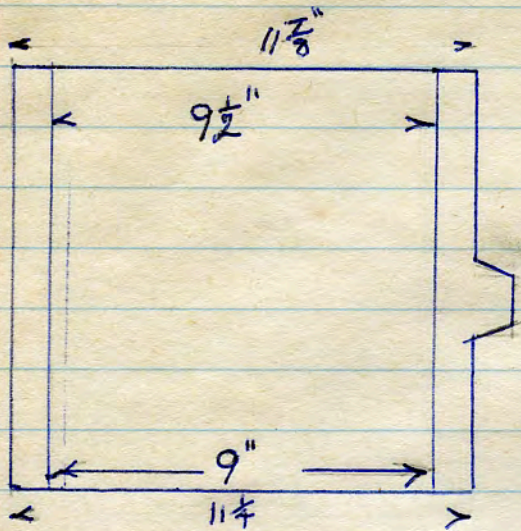

Ventilator.

1175

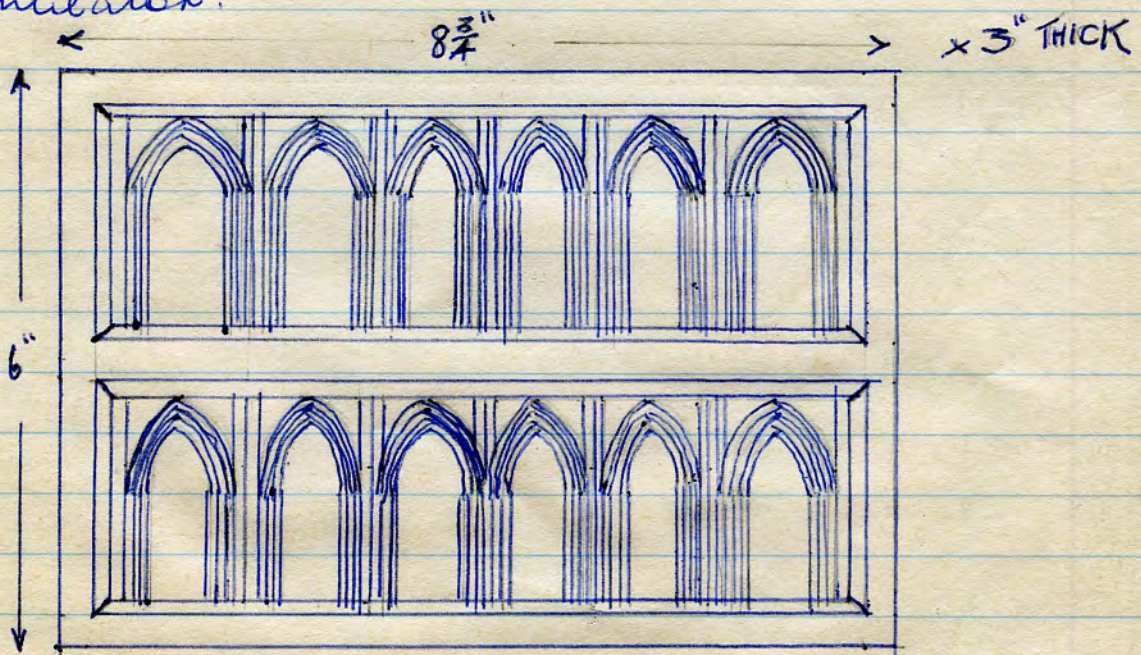

Back Roman Road, Sheetham. M/n. (27. 8) '78

Green glazed dado tile. (Lower Broughton - house dem)

3 shades.

1190

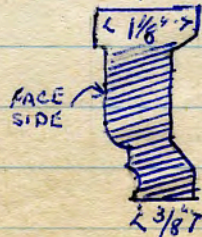

(27. 8. 78)

Reverse stamped. C P & C C ENGLAND.

Garden edging tile. 9" x 6³/₄" x 1". plain reverse.
dark brown salt glaze. 5 lbs.

(W. Parks. Guide, B/burn)
(2. 9. 78)

1192
x

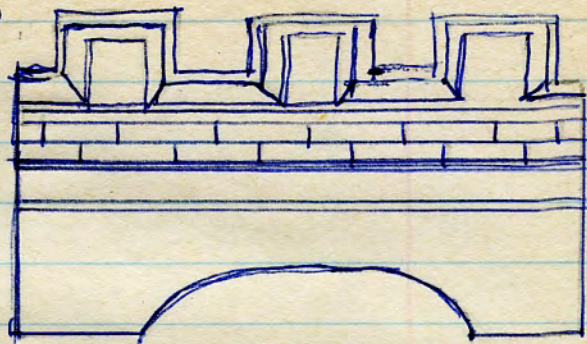

Garden edge tile. 9" x 8³/₄" x 1". same both sides
light salt glaze. rope design.

(W. Parks. Guide, B/burn) (2. 9. '78)

1193
x

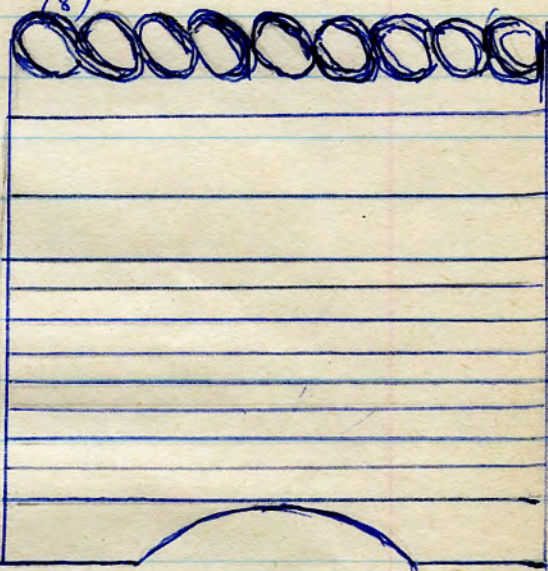

Garden edge tile 8⁵/₈" x 8¹/₂" x 1". same both sides
salt glaze., rope design.

W. Parks. Guide, B/burn

(2. 9. 78) 6 lbs

1194
x

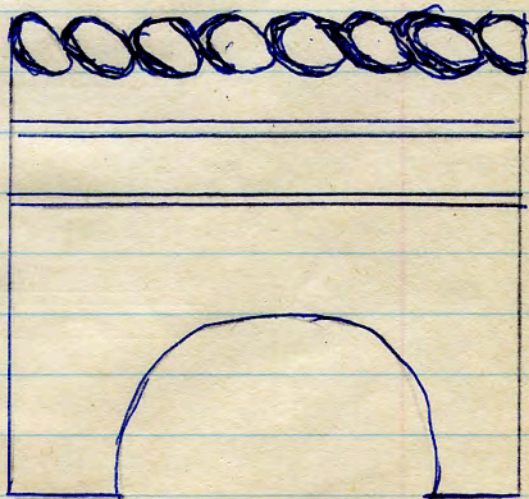

Blue Wall Capping
Length $11\frac{3}{4}$ "

1195
x

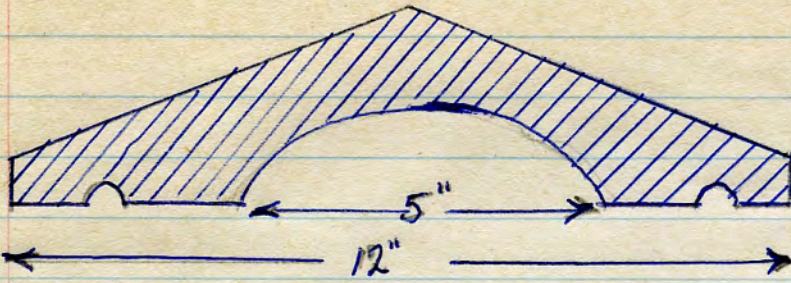

Lower Broughton M/s.
27. 8. 78

Blue tile 6" x 6" x 1" Stamped reverse T. Peakes M
(Snydale 3. 9 '78)

1214
x

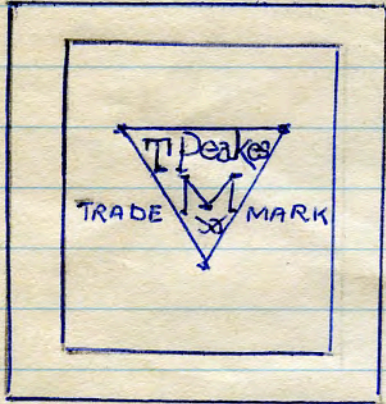

3 1/2 lbs.

1215
x

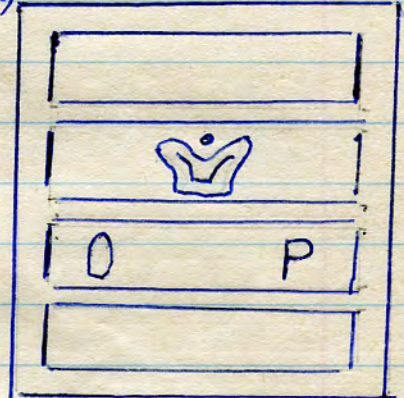

3 1/2 lbs

Red tile. 6" x 6" x 1". Stamped
reverse - crown O P
(Snydale 3. 9. 78)

ELECTRIC CABLES DCEW LT R.D. No 804561
(3. 9. 78 Snydale) 7 lbs.

1216
x

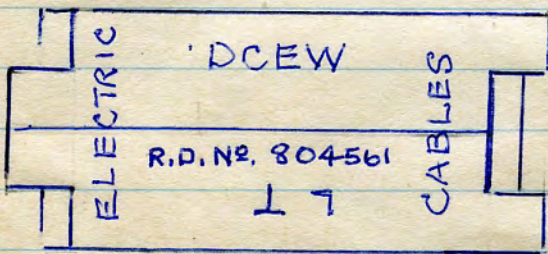

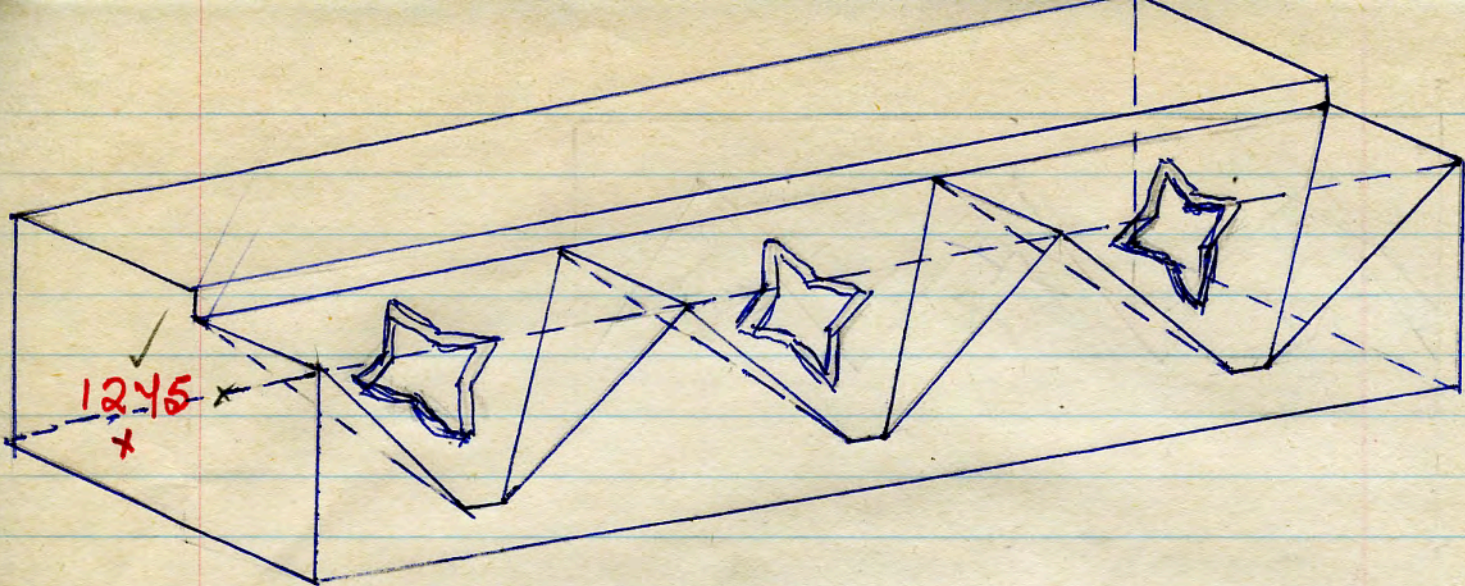

Decorative stringcourse brick 9" x 4 1/2" x 3". 78s
single panel - reverse.

No name marked - but we presume made by Ashworth Rochdale.

(Edward Place off Bawford St. dem. site. 10. 10. 48)

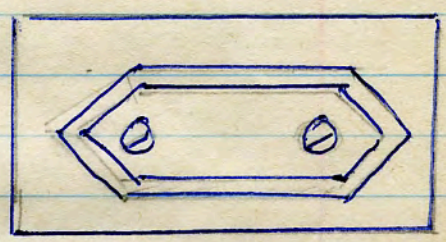

✓
1246
x

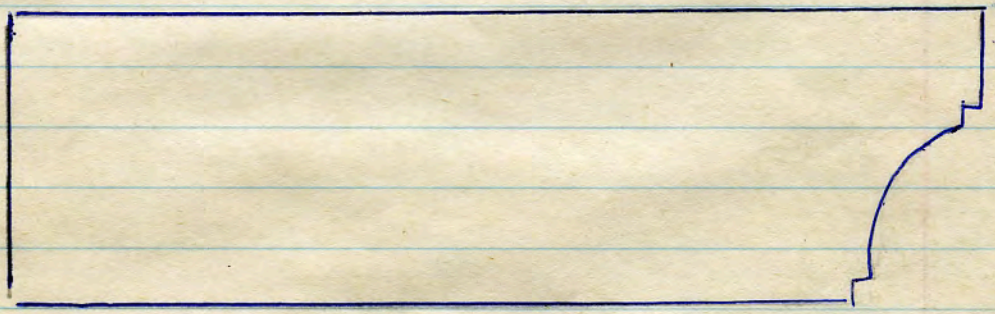

corbel 14" x 4 1/2" x 3". from same site as 1245.
single panel - one side

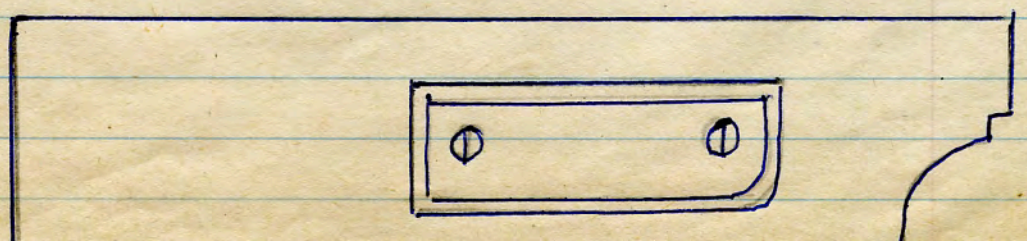

200

✓
1278
x
+

Decorative boss $6\frac{3}{4}'' \times 6\frac{3}{4}'' \times 2\frac{3}{4}''$ $6\frac{1}{2}$ lbs
Circular panel $3\frac{3}{4}''$ diam in reverse. $\frac{3}{4}''$ deep.

Pattern in relief on obverse.
(W. Park, Guide, near to Roman Road. 14. 10. 78)

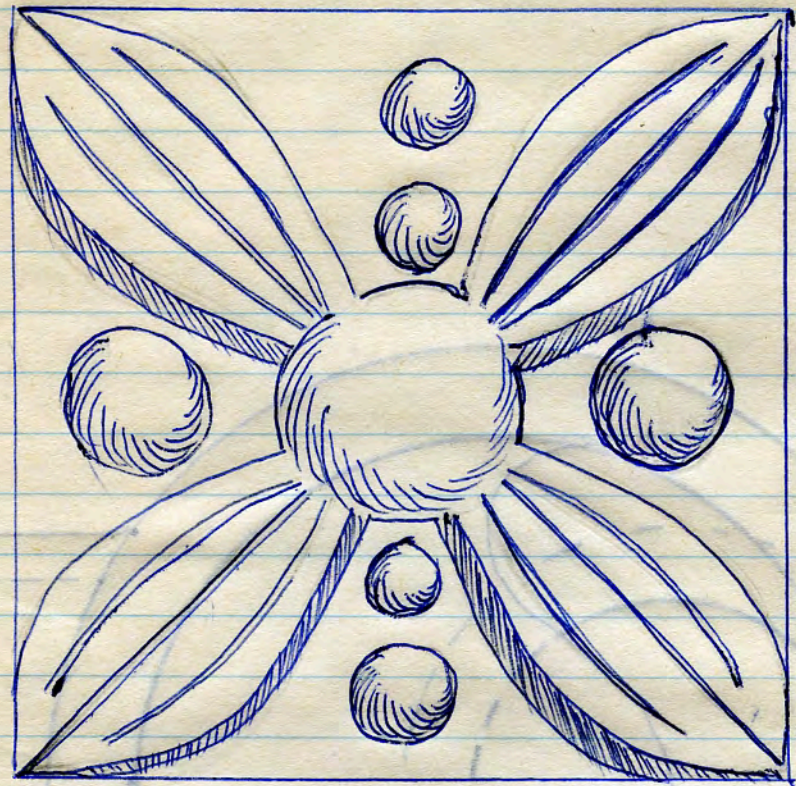

bill piece, throated - (could be string course brick)
 $8\frac{3}{4}'' \times 6'' \times 3''$ (14 lbs)

13 lbs.

✓
x1282

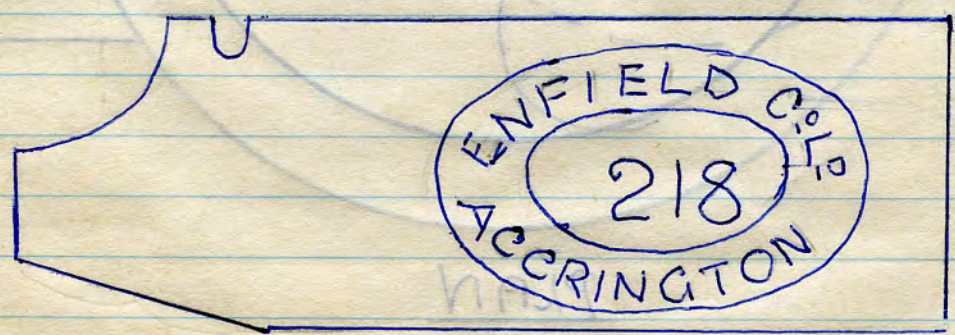

Stamped on end. (Petre St, Clayton le Moors 15. 10 78)

1285 ✓ Terra cotta flag. ICA marked on 1 edge. (13 1/8" x 2")
 19 1/4" x 13 1/8" x 2" no panels.
 (blayton le moors dem. Petre St. 15. 10. 78)

1295 ✓ DENNIS RUABON. 9" x 6 3/4" x 3".
 string course brick (through support to flat concrete roof).
 letters stamped on one end.
 (Dodgson St dem. R/dale. 5. 11. 78)

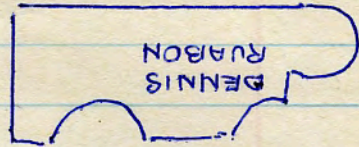

1315 ✓
 x x

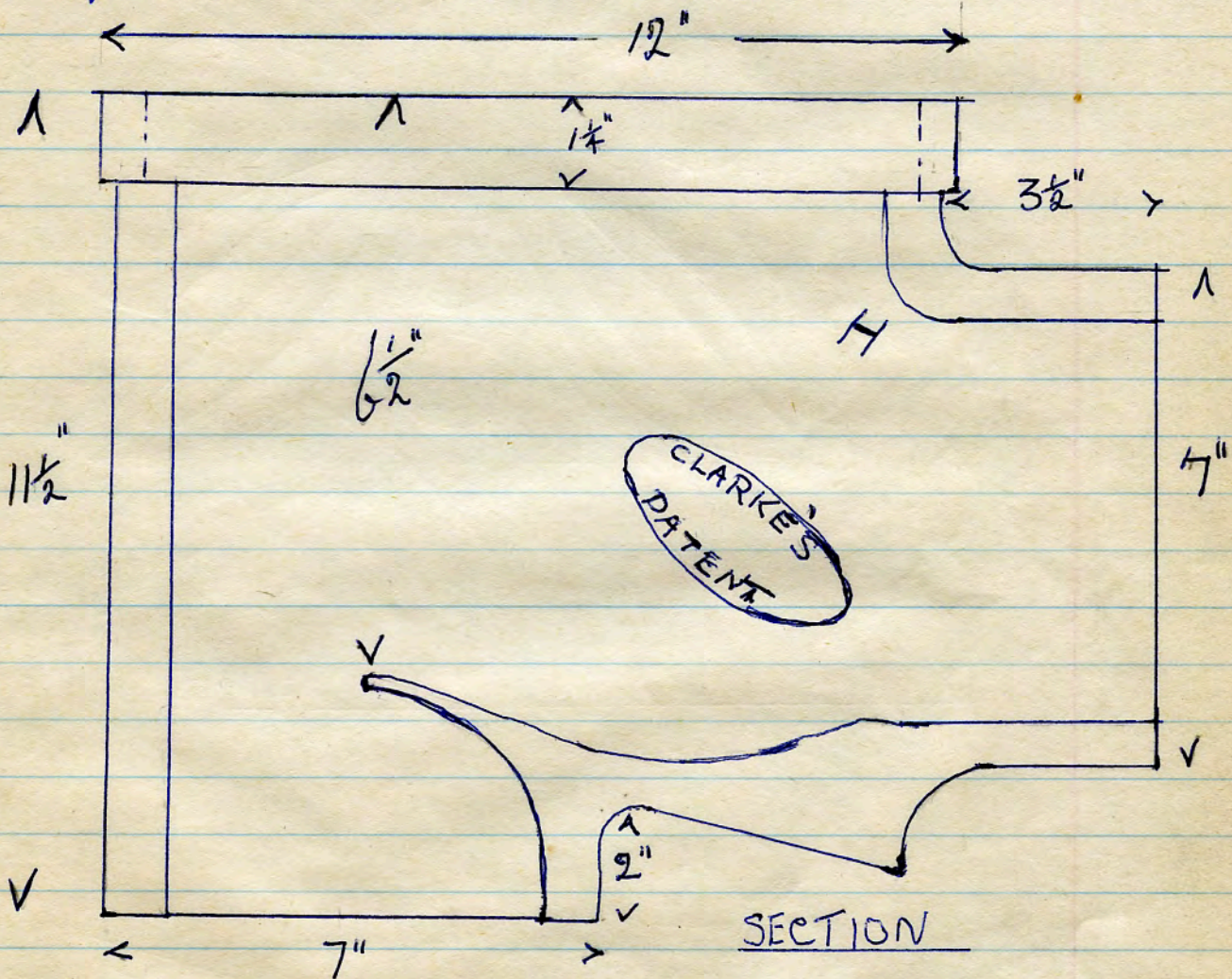

Mr. LAW 17 Jordan Street Rawtenstall 19/11/78

✓
1318
x
x

initials
J J (operative) (Jabez Thompson, Northwich)
Decorative brick, return end.
deep $1\frac{3}{4}$ " reverse
~~two~~ panels, letters stamped on one side.
(M/n Road - pub dem. Wigan. 25. 2. 79)

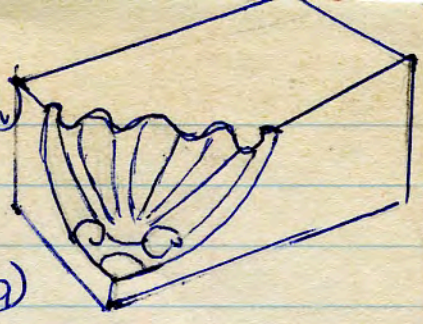

Wall capping. $1\frac{1}{4}$ " x 7" x 3"
panel on one side. $2\frac{1}{2}$ " diam semicircle on bottom
no name. (Gippings Lane, Bolton. 25. 2. 79).
9 1/2 lbs. off Blackburn Road.

✓
1319
x
x

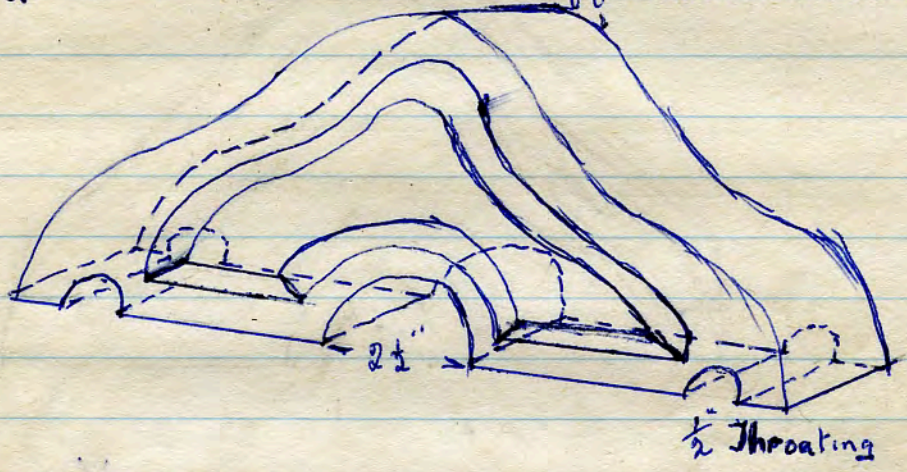

String course. Flower & leaves in relief $\frac{1}{2}$ " deep
 $12\frac{1}{2}$ "

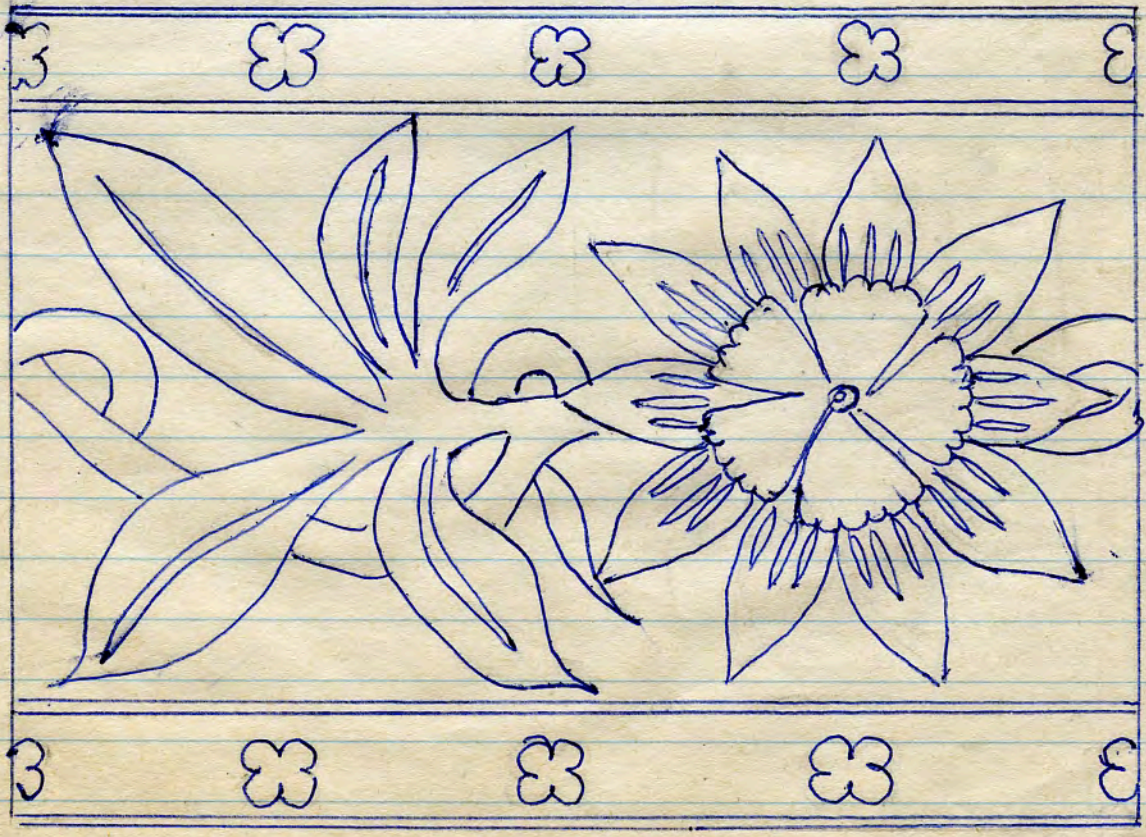

9 3/4"

✓
1320
x
x

1 large panel 1" deep reverse $9\frac{1}{2}$ " x $6\frac{3}{4}$ "

W BLYTH

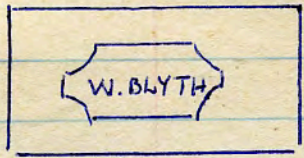

✓
1361x floor tile, 9" x 4 3/8" x 1 1/16",
x single stamped panel, letters in relief
Mrs Los, Woodmansey Hs. Beverley, Humberside. (18. 4. 79)
No name

✓
1362x Hand made wall capping
x Mrs Los, 18. 4. 79
Woodmansey garden.

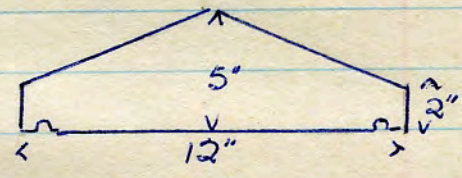

1363x Air vent 9" x 3" x 2 5/8" Woodmansey.
x glazed throughout.
Mrs Los, 18. 4. 79



Gauged brick for flat arch.

1364x

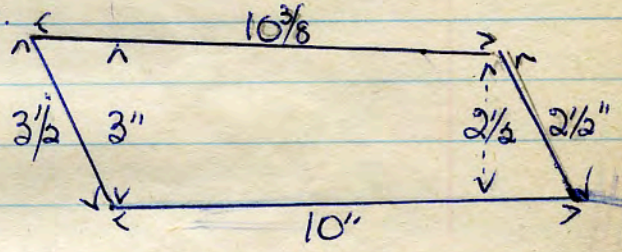
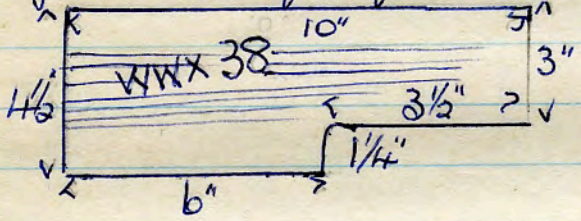

letters stamped (incised), serrated by hand to form key
Stamford Mill, Lees Brook, Oldham. 24. 4. 79

blay draining tile, arched shape 4" wide 5/8" thick
13" long, 3" inside height. (Should have flat base of
burnt tile to complete it)
1365x (Mrs A. Los. 18. 4. 79)
x Woodmansey (garden)

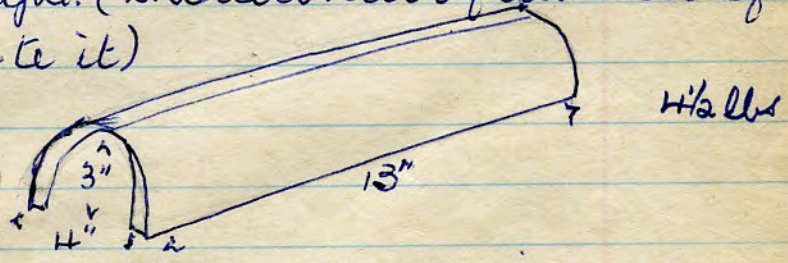

Square drain tile 13" long x 3" x 3" with 2" bore.

1366x

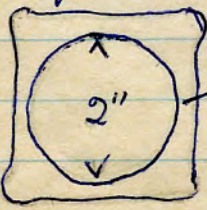

Hemingbrough
5/8" thick. (Mrs. A. Los 18. 4. 79) 4 1/2 lbs.

DENNIS RUABON flinth sill brick, name in panel on base. very shallow panel no name on top. 9" x 5 5/8" x 3 5/8" 3" thick. letters incised.

✓
1387
x

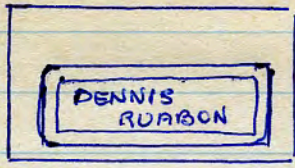
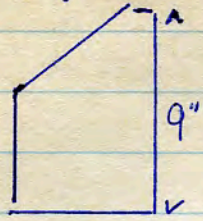

(Lower Mosley St. M/s. 20.5.79).

DENNIS RUABON 9" x 4 1/4" x 2 5/8" no panels uneven elliptical hole in centre 2" x 1 1/2" approx. serrated both faces. stamped PHII letters stamped (as above - 20.5.79)

✓
1388
x

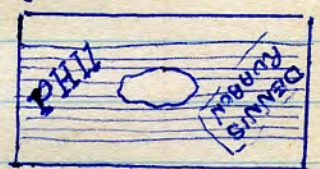

DENNIS RUABON Decorative brick. single panel each side. letters incised (as above)

✓
1389
x

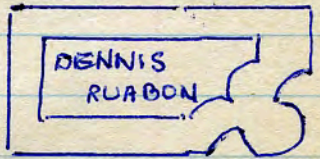

DENNIS RUABON Decorative quaged arch brick, 10" x 4 1/4" x 3 1/8" - 2 5/8" no panels 2" x 1 1/2" rough elliptical hole in centre letters stamped. PH 12 serrated except face. (as above)

✓
1390
x

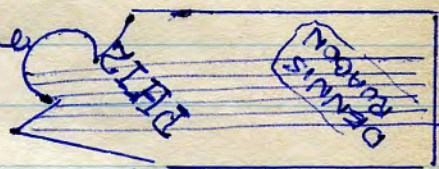

DENNIS RUABON PH 15 8 3/4" x 2 5/8" x 4 1/4" Decorative brick. similar to above. smaller in length not quaged.

✓
1391
x

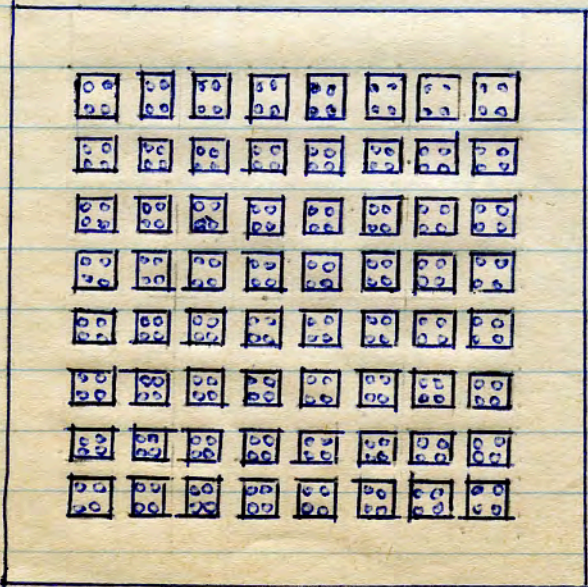

✓
1414
+

12" square tile said to have been from hop-drying room floor at Gyles Brewery at Lheddleton

6 1/4" x 1" squares with 4 x 1/8" holes to base of each square 1 1/2" thick 13 lbs.

hard burnt - resulting colour is iron blue.

slight camber to floor line

(1/2 5-70 Mr V. Taylor Lheddleton)

DENNIS RUABON PH 9

no panels, elliptical hole in centre
name & letters stamped 1 face

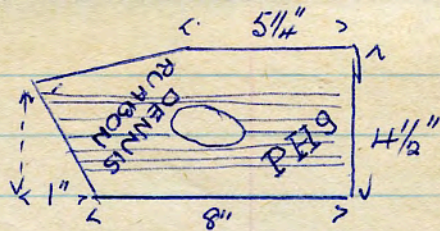

✓
1418

both faces serrated.

(Lower Mosley Street Imps. 24. 5. 49)

DENNIS RUABON PH 13 springing brick

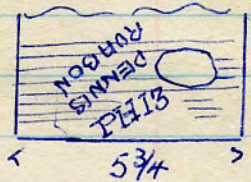

✓
1419

as 1418 5 3/4" x 3" x

INGHAM ELECTRIC 9" x 5" x 2"

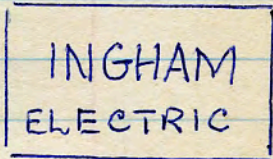

✓
1547

no panels, letters incised, 1 side only.

(Wyke - Elec. dumping ground. 26. 8. 79)

Part floor paver, blue. R^D 6 stamped
9" x 6" x 2 1/4" (original).

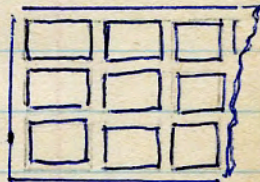

✓
1548

(Dawson Station 25. 8. 79)

DANGER LBC ELECTRICITY 13" x 7" x 2 1/2"

PHORPRES

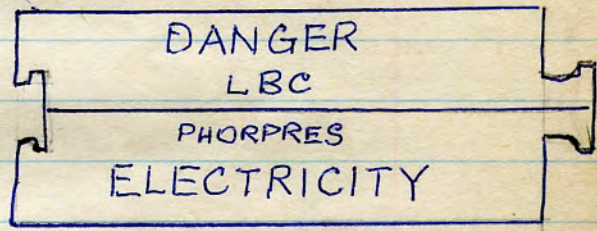

✓
1549

letters incised 1 side only.

(Wyke. Elec. dump 26. 8. 79)

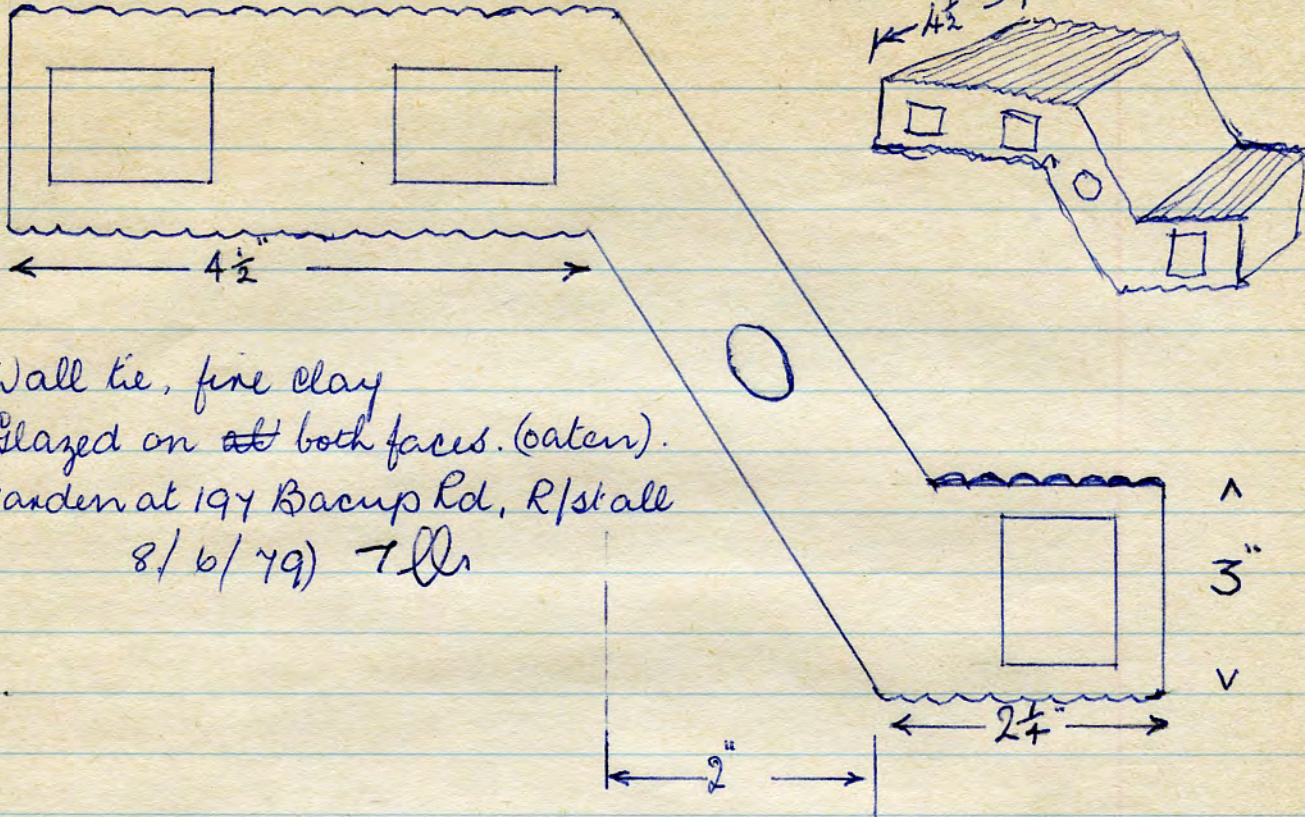

1421 x
 Wall tie, fine clay
 Glazed on ~~at~~ both faces. (aten).
 (Garden at 197 Bacup Rd, R/stall
 8/6/79) 7 Br

Dado or plinth brick
 Brown ^(salt) glaze on face edge.
 No name.

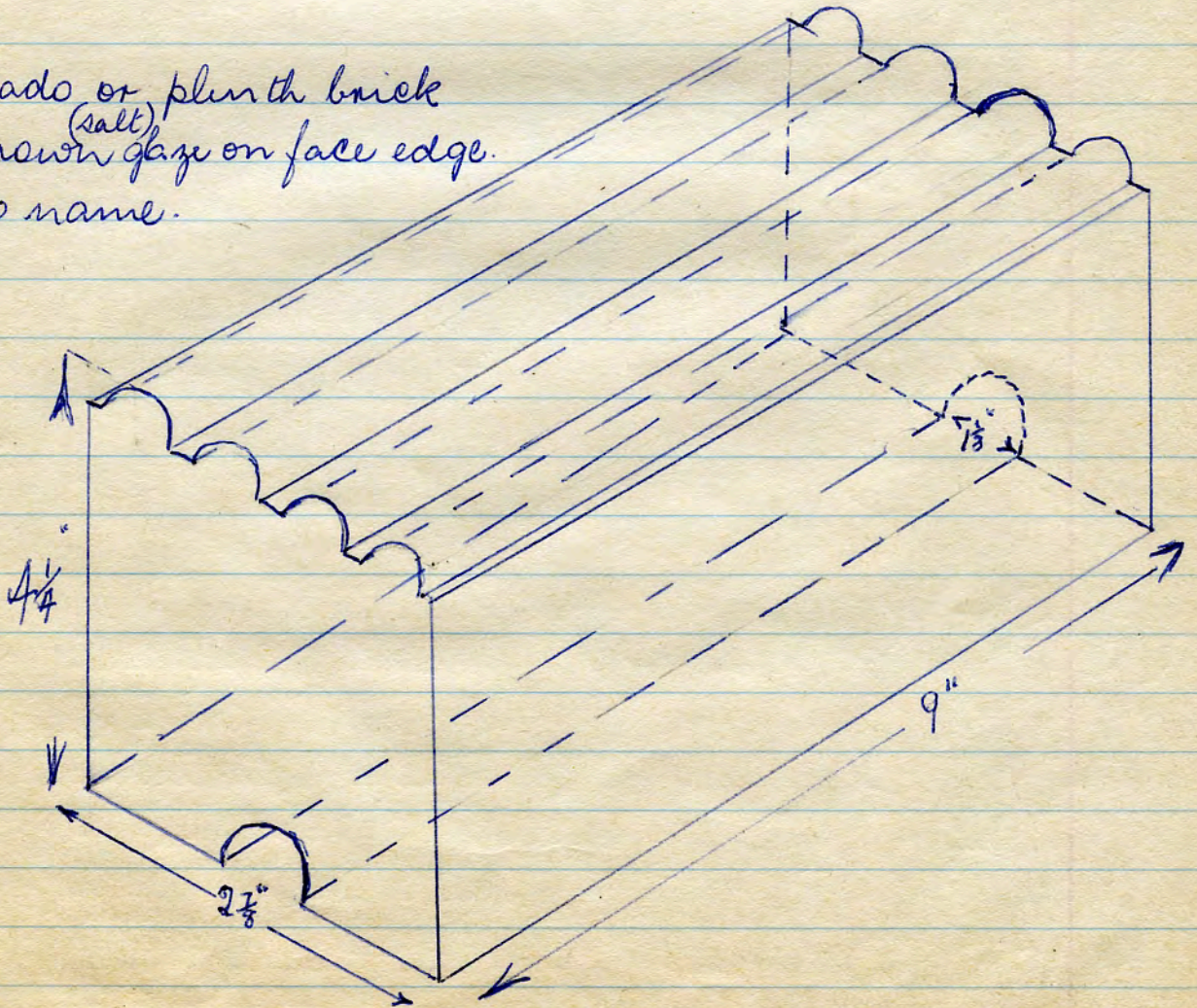

1422 x

(Garden at 197 Bacup Rd, R/stall 8/6/79)

x
1426
x

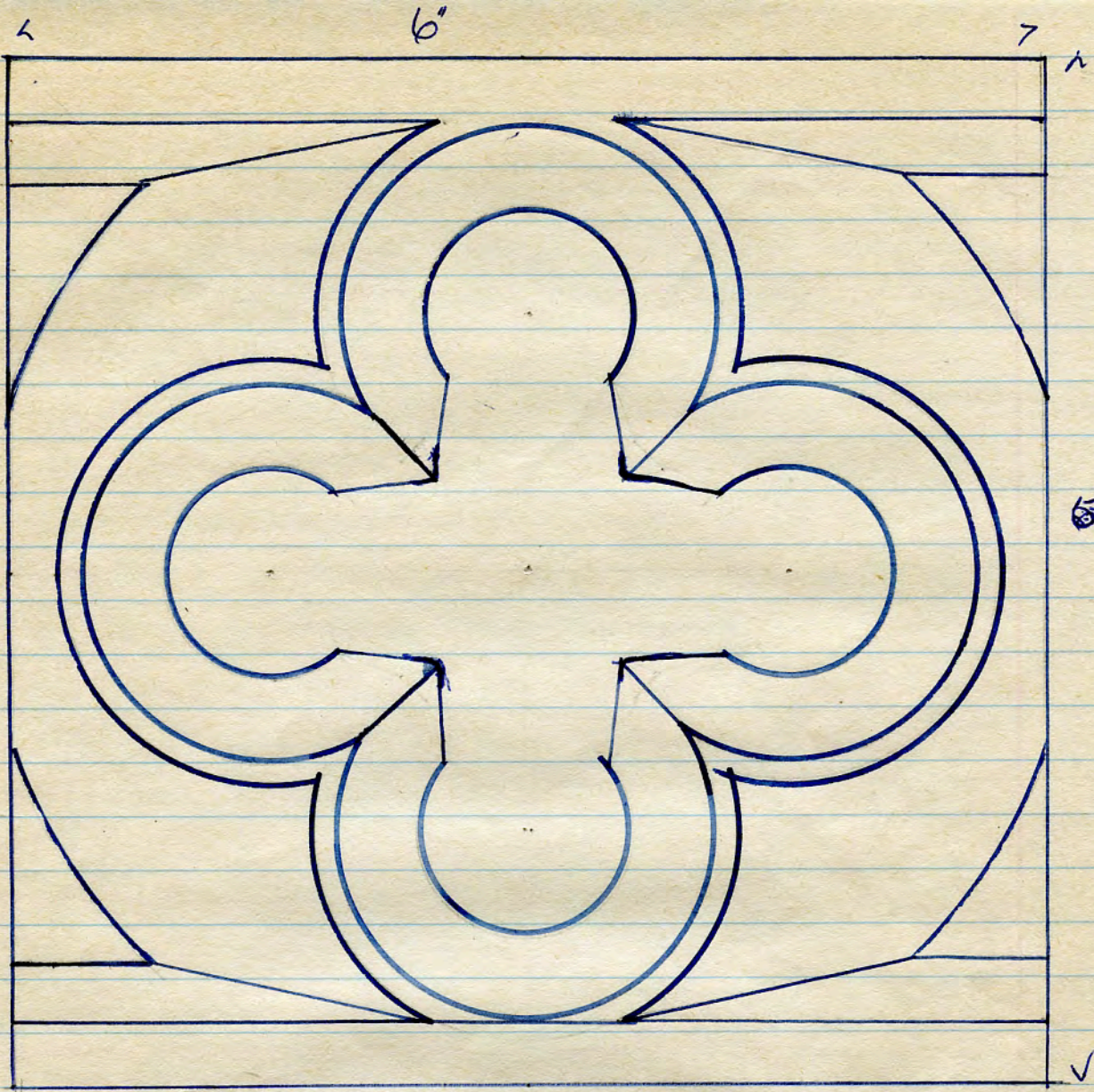

6" x 5 3/4" x 1 1/4" Cusp - decorative (plinth mould)
no panels. Made by Gundry, Wolstenholme Hall.
6"

x
1437
x

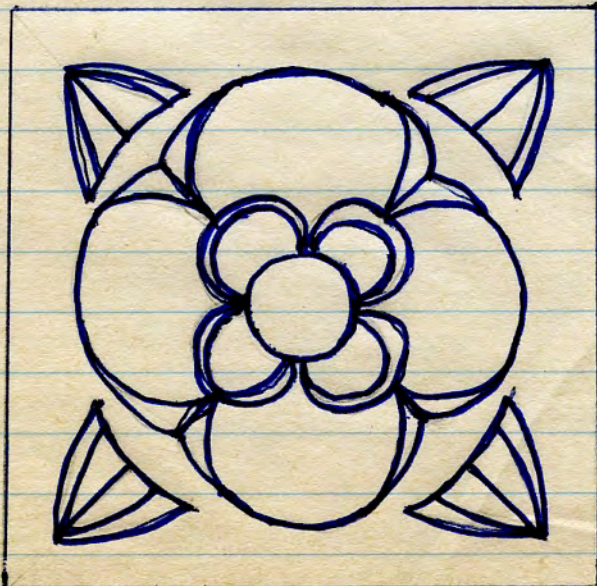

Cusp - as above.
6" x 6" x 1 1/4"

6"

Wall capping. $14\frac{3}{4}'' \times 4'' \times 2\frac{3}{4}''$
 small panel one side only,
 no name.

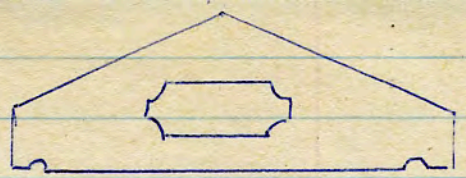

1505 ✓
 × Mrs Ros - found at Bessle, where there was once a
 brick works - 22. 4. 79).

Garden edge tile $4\frac{7}{8}'' \times 4'' \times 1\frac{3}{16}''$
 3 panel on one side, $5'' \times 1\frac{3}{16}'' \times \frac{1}{4}''$
 3 points at top edge. no name
 (Summit L/borough 28, 4. 79)
 dark brown salt glaze $5\frac{1}{2}$ lbs.

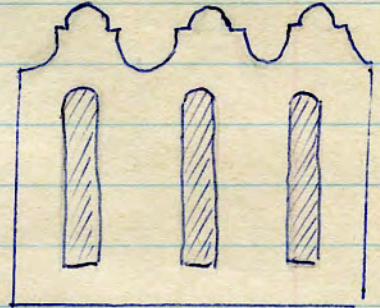

1504 ✓
 × floor tile. $9'' \times 9'' \times 1\frac{3}{4}''$.
 no name. 5 circular fixing ridges.
 (Hoyland. 15. 7. 79) bottage dem.

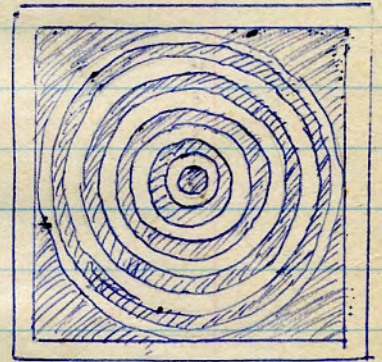

1508 ✓
 × ELECTRIC CABLES R D No 804561
 cable cover. $6\frac{1}{2}$ lbs.
 Hoyland - Stainfoot. 15. 7. 79.

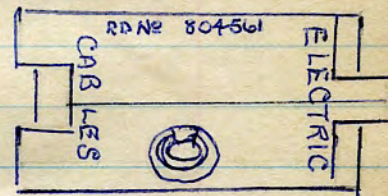

1613.
 × ×

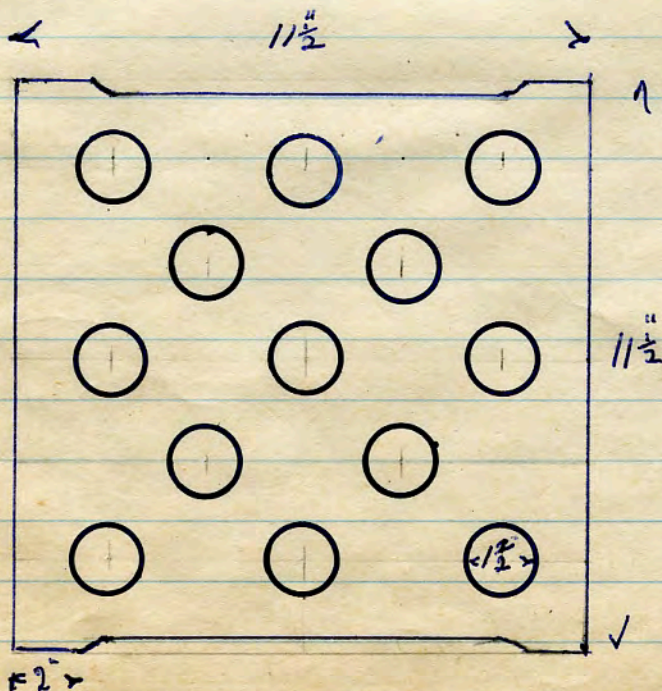

$3\frac{7}{8}''$ thick

Wt 24 lbs.

Wire grate from R. E. Knowles, Furness Vale,
 made of fine clay for use in their own kilns

Kiln stand
for
Sanitary
Tubes

16
11
3

✓
1511
x

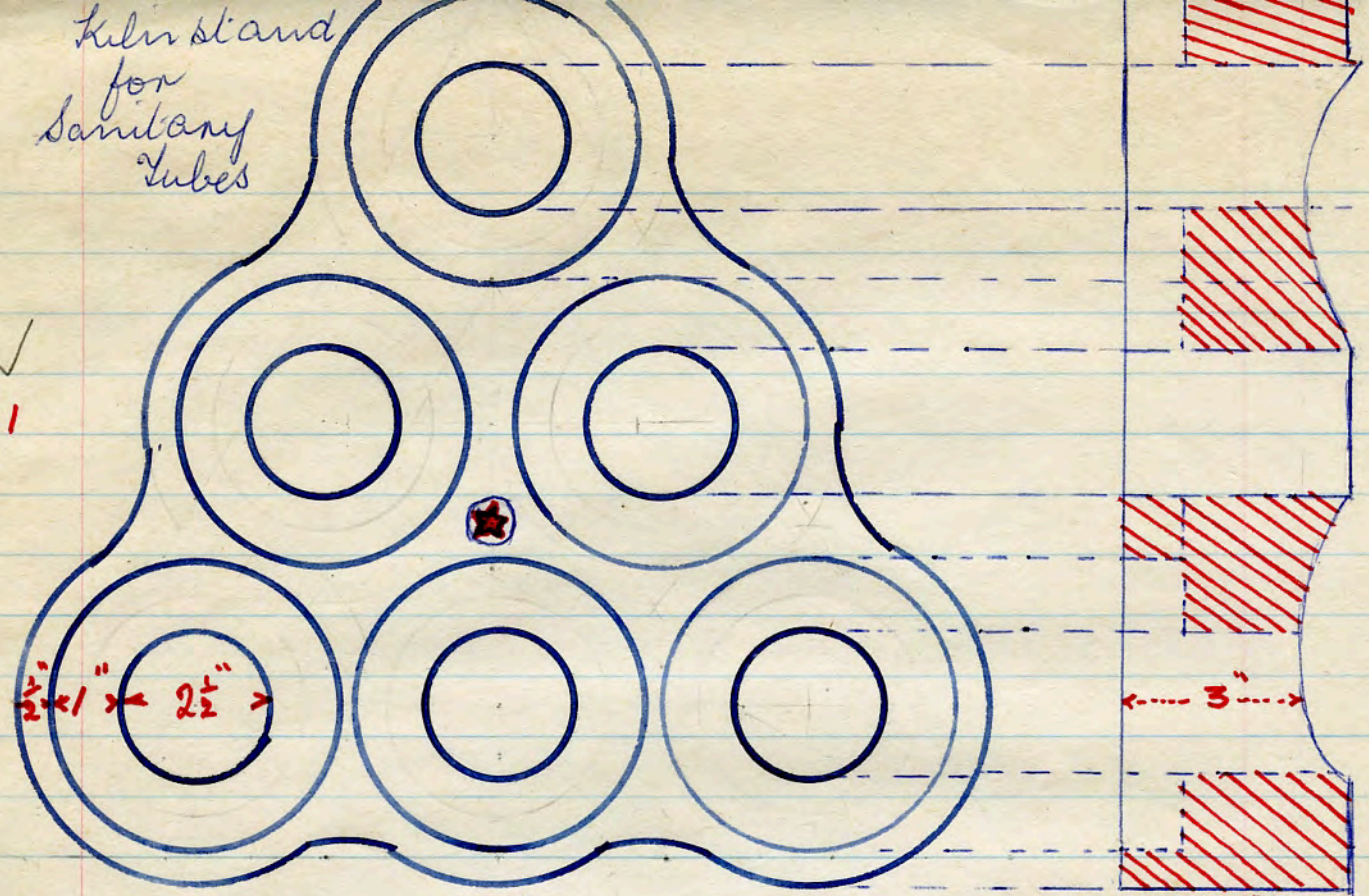

← 17 1/2" →
29. 7. 79
Stanning clay Works
Littleborough
Ventilator blocks
9

✓
1512
x

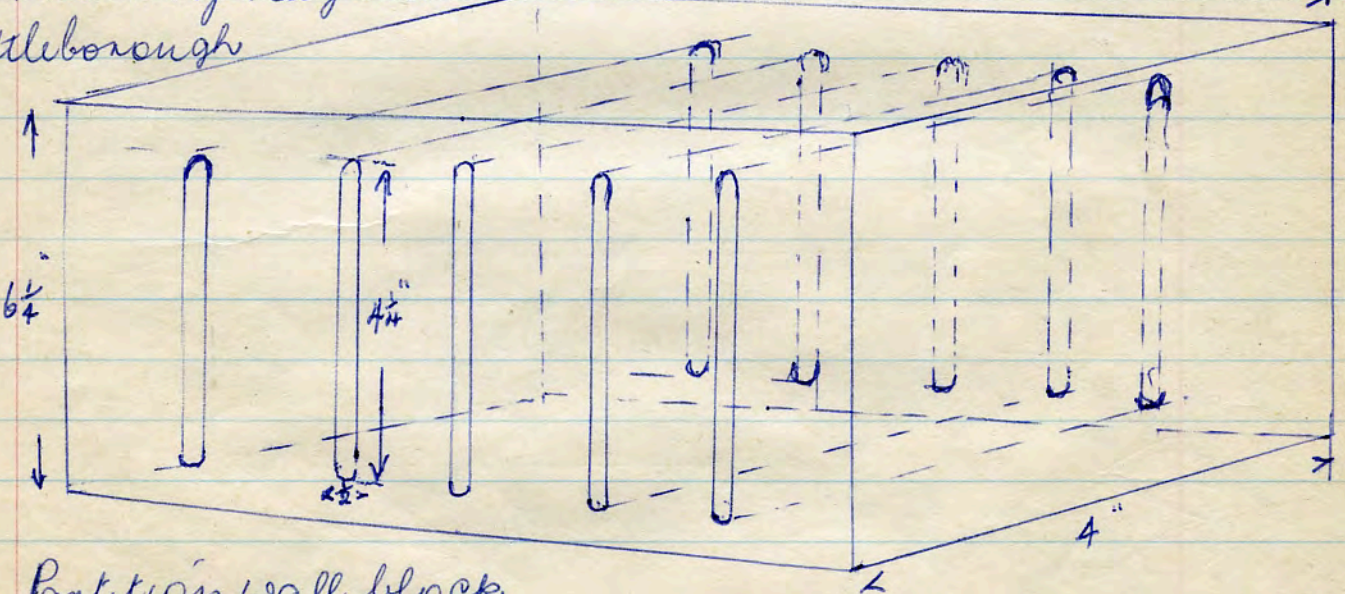

Partition wall blocks
no name

groove scraped out by thumb

✓
1513
x

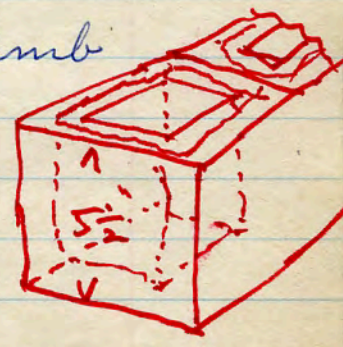
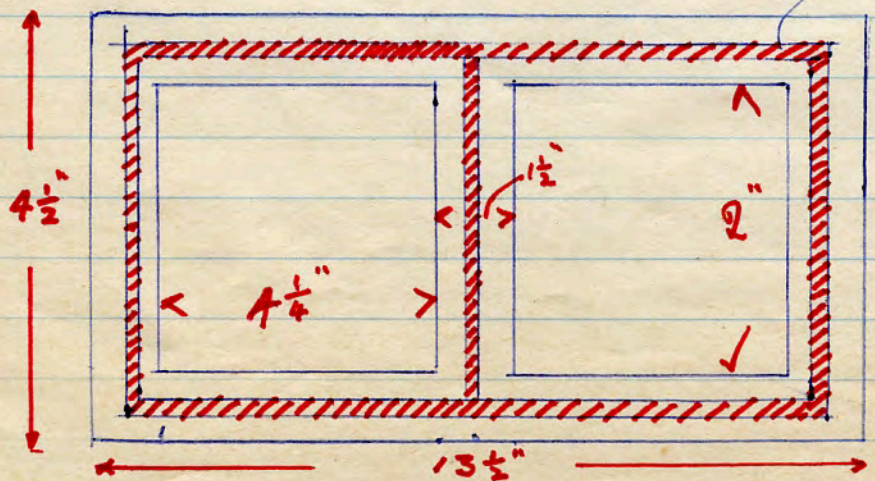

Stanning clay Wks
29. 7. 79.
Littleborough.

✓
 1518 x Dado brick 9" x 5 1/2" x 3"
 No name. Stamped ES21 on end,
 uneven elliptical hole through centre
 (Burnley Gas Works dem. 21. 8. 79)

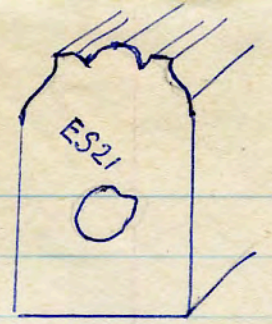

✓
 1563 x IRON in single panel reverse
 Blue black floor tile. 9 1/8" x 4 3/8" x 1 1/2"
 letters in relief.
 (Lark Lane, Stockport dem. 9. 9. 79)

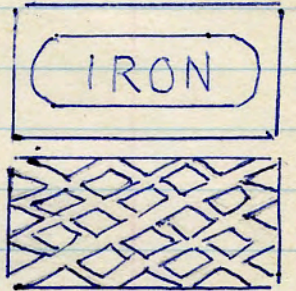

✓
 1581. x x Dentil 6lbs, buff terra cotta
 6 1/2" x 4 3/4" x 5 7/8" (6lbs)
 (Withnell Brk Wks (closing) (7. 9. 79)

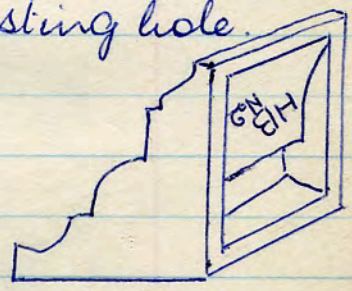

✓
 1582 x x Dentil. Stamped WITHNELL BRICK & TERRA COTTA CO
 red terra cotta 2 5/16" x 2 5/16" x 2 5/16"
 panel each end. (2lbs) (7. 9. 79)

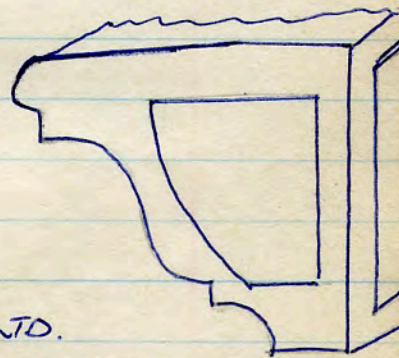

WITHNELL BRICK & TERRA COTTA CO 1912 LTD.
 One course, moulded header, mitred return
 Weathered on mould edge.
 ✓
 1606 x 9" x 6 1/2" x 3" (14lbs)
 single panel, letters incised

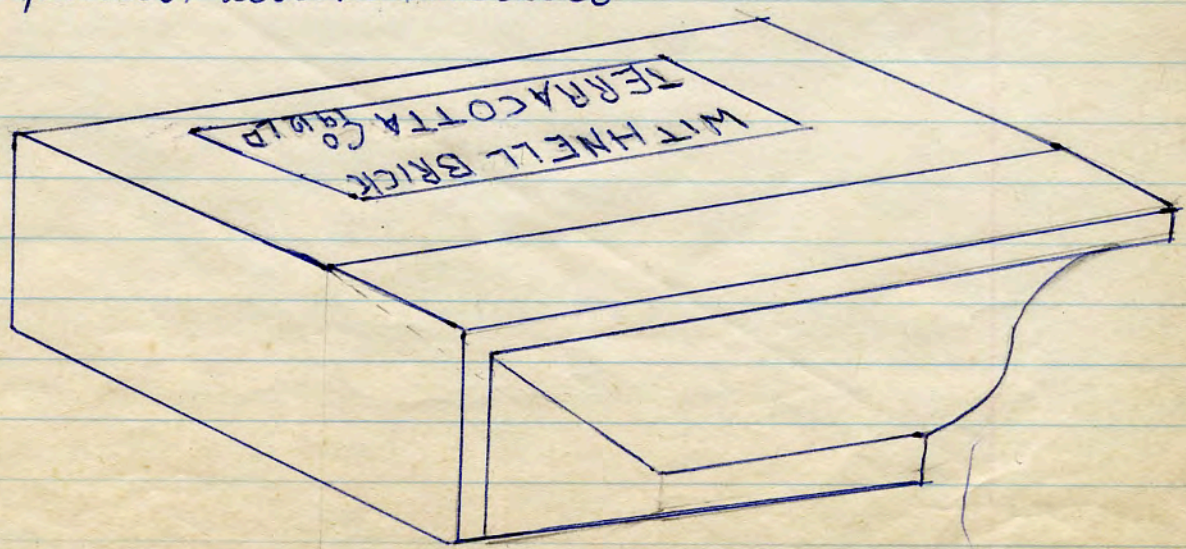

WITHNELL BRICK & TERRA COTTA Co. 191

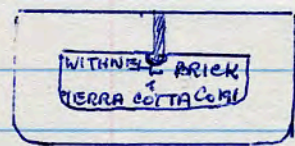

✓
1596
x

double 1/8" bull nose, single panel & lettering both sides. letters incised 8 5/16" x 4 5/16" x 3 3/8"

(Withnell Brk Wks. (closed) 19. 9. 79) (9 lbs)

WITHNELL BRICK & TERRA COTTA Co 1912 LTD

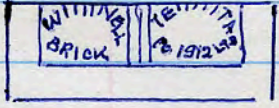

✓
1597
x

8 1/2" x 3" x 2 5/8" purpose made closer (Queen Kovey)

double panel ob. single rev (as on complete brk. letters incised. (Withnell 19. 9. 79) (6 lbs)

WITHNELL BRICK & TERRA COTTA Co 1912 LTD

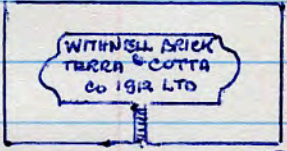

✓
1598
x

8 3/4" x 4 1/4" x 3" (10 lbs) jamb stop or start brick single panel each side, letters incised

(Withnell 19. 9. 79)

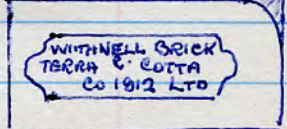

✓
1599
x

No name, no panel, cove mould brk. 9" x 4 1/2" x 3" (8 lbs)

(Withnell 19. 7. 79)

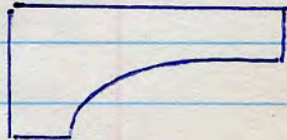

✓
1600
x

WITHNELL BRICK & TERRA COTTA Co 191

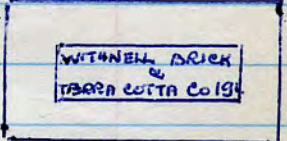

paving brick, red, single panel. letters incised. (13 lbs) 9 7/8" x 4 1/2" x 3 1/2"

(Withnell 19. 9. 79).

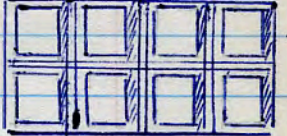

✓
1601
x

3 flat arch bricks to suit 3 courses.

✓
1602
x

no names, no panels. each has 2 perfs 3/4" diam.

✓
1603
x

all at different pitches. (Withnell. 19. 9. 79).

WITHNELL BRICK & TERRA COTTA Co LTD LANCASHIRE

stamped on 1 edge. 8 3/4" x 8 1/4" x 4 3/8" (20 lbs)

rectangular terra cotta block for 3 course of brickwork.

bears large letter S in relief. - decorative scotia mould and small 1/4" square on 1 edge. letters 3/4" x 3/4"

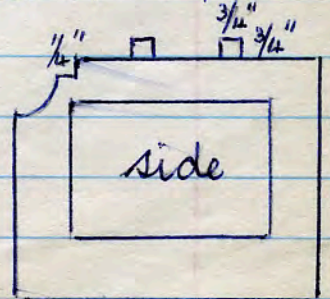
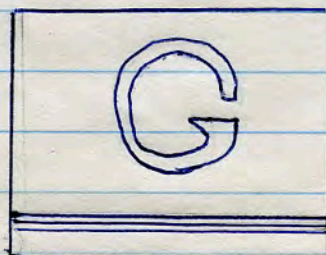
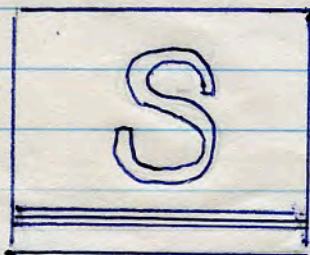

250 ✓
1605
x

As 1604 - bearing the letter G in relief (20 lbs.)

1609
x

WITHNELL BRICK & TERRA COTTA CO 1912 LTD.
8 1/4" x 6 1/4" x 3". sill return end 12 lbs.
single panel one side only, letters incised

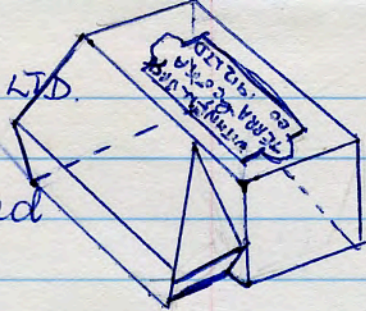

Decorative corbel in salt glazed fire clay.
12" x 6 3/4" x 4". no name, no panels.

1611
x

(Found at house dem. Rossendale Rd, Burnley. 23. 9. 79)
Possibly made by Ducketts.

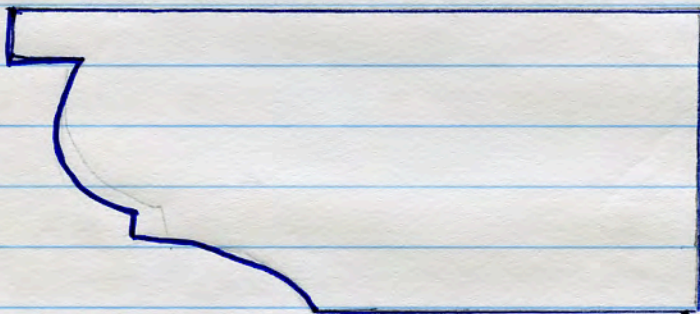

One side shows the grain of the timber box in which it was made.

1612
x

depth 4 1/4"
of frog.

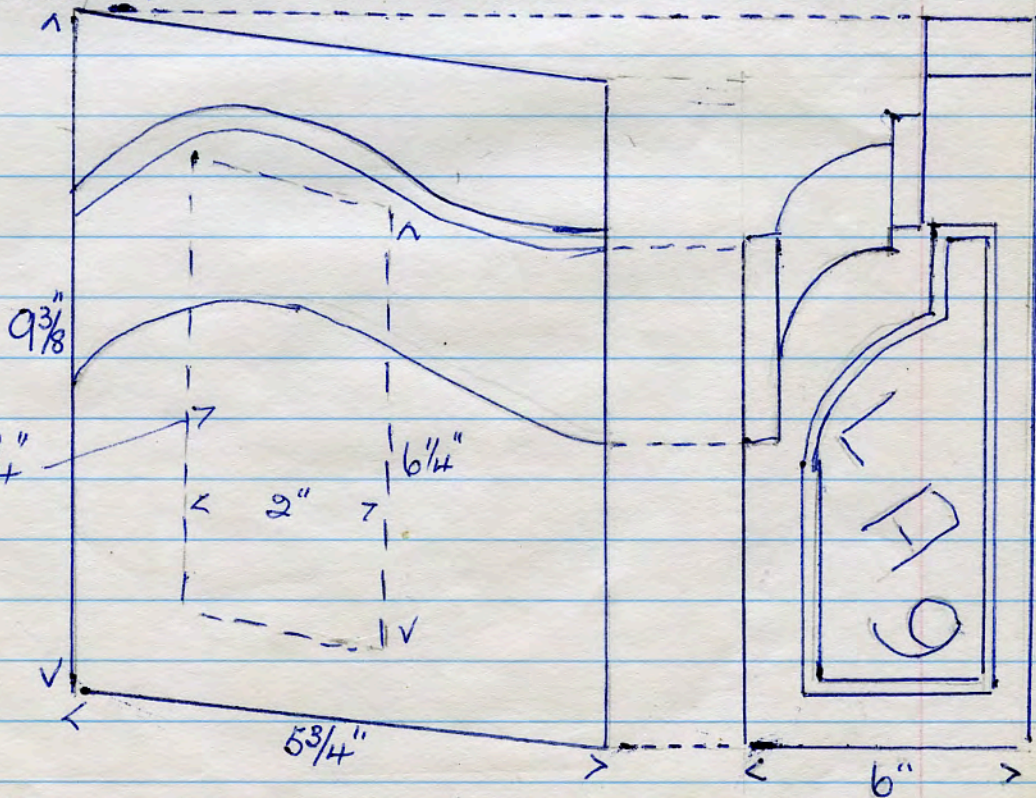

Withnell. 7. 9. 79.

WITHNELL BRICK & TERRA COTTA Co. 1912. LTD.

✓
1607
x

One course moulded header (stetcher)
Single panel, incised letters $8\frac{1}{4}'' \times 5\frac{1}{8}'' \times 3''$ (12 lbs)
chamfered return
for 3" brickwork.

7. 9. 79

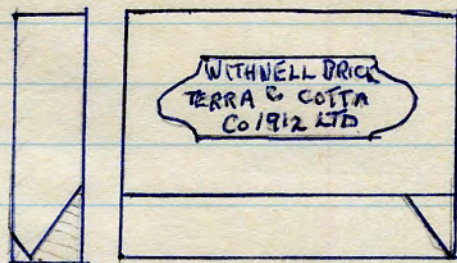

✓
1610
x

WITHNELL BRICK & TERRA COTTA Co 1912 LTD.
Window sill return, including steel finish with 2
mason's mitres for (21 lbs) 3" brickwork, $9'' \times 11'' \times 3''$.
double panel one side, letters incised faint. 7. 9. 79

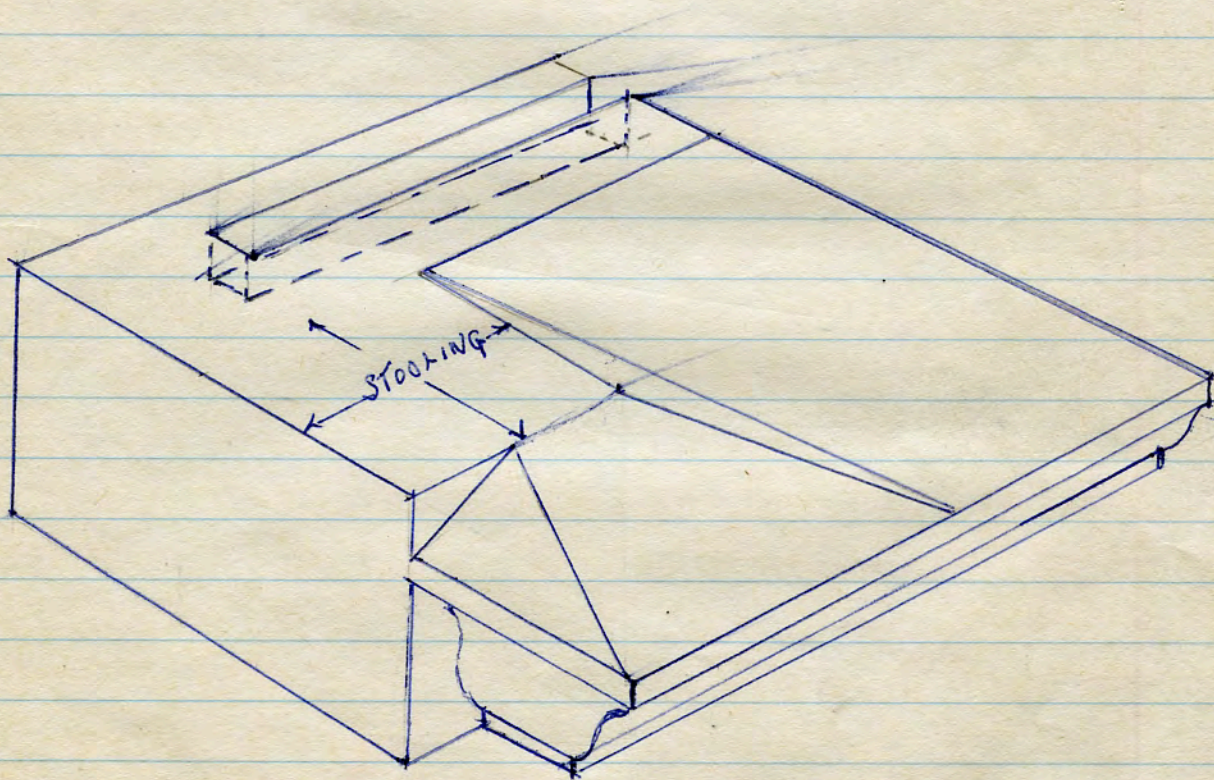

44 000.000

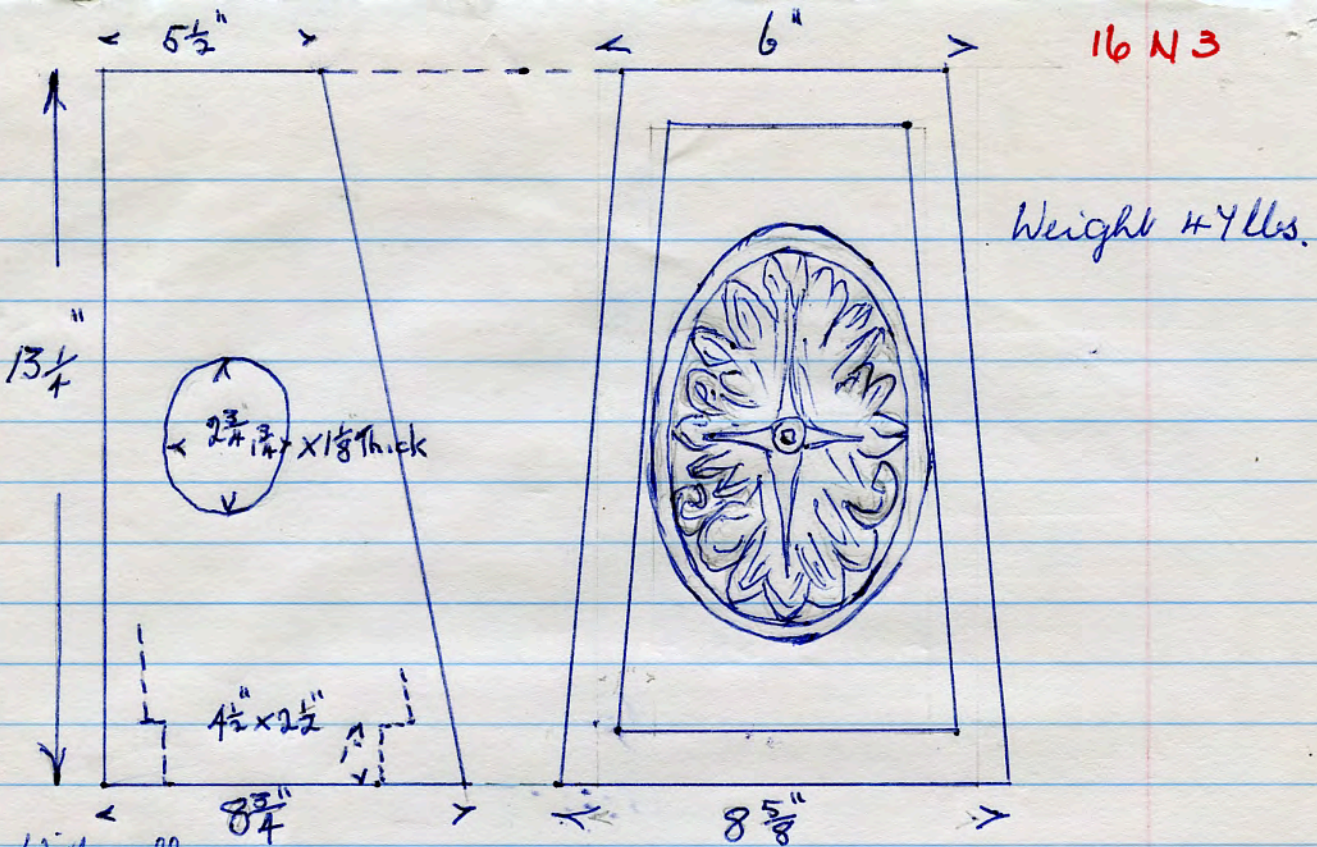

✓
1614
x x

16 N 3

Weight 4 1/2 lbs.

Withnell
~~Walsfield~~ Bks Wks - key stone for arch 7. 9. 79
(Display. Sept 12ⁿ. 49)

✓
1615
x x

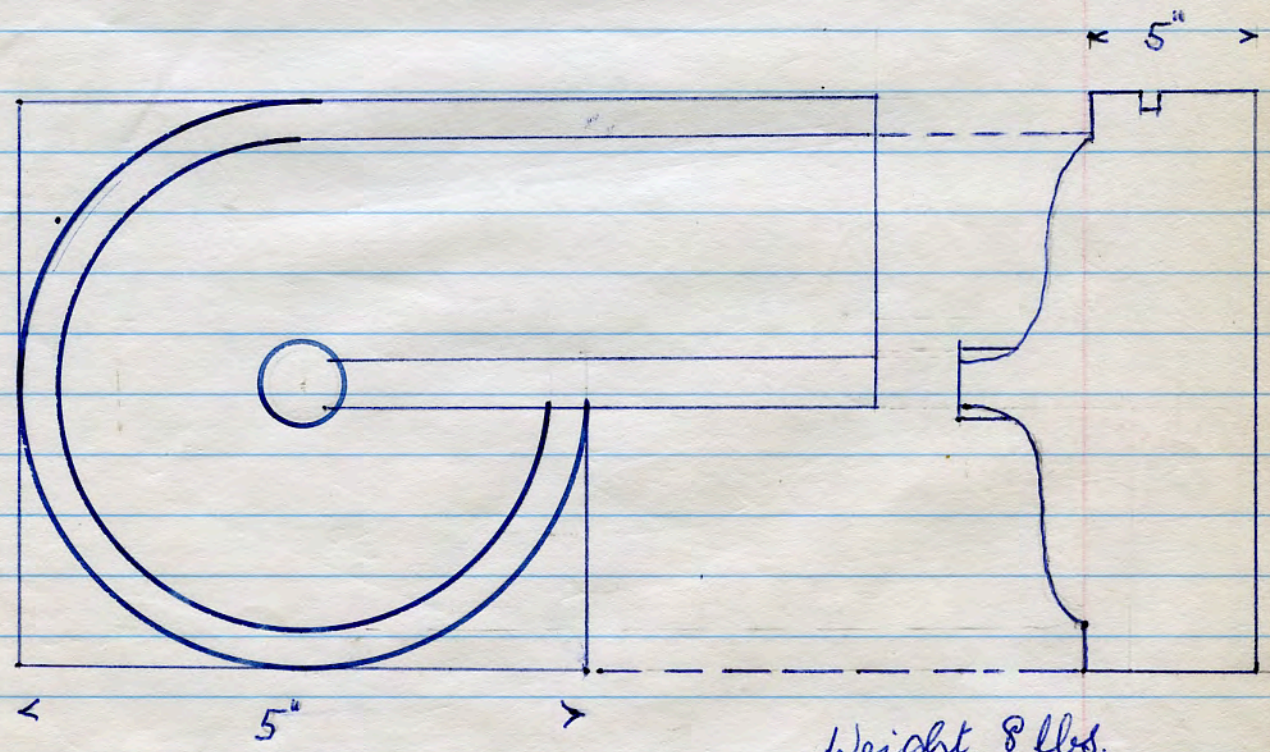

Weight. 8 lbs.

Withnell Bks + Terra botla bo. 7. 9. 79.
Decorative stop end

1616

Weight - 8 lbs

✓
1616.
x

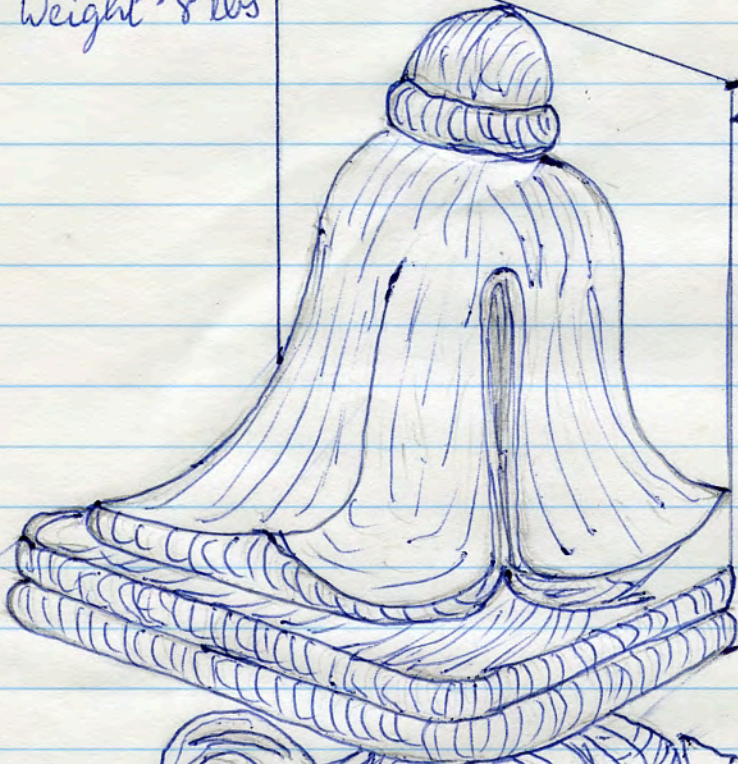

4" 7. 9. 79
Widnell Bks & Terra
Cotta Co Ltd.
Weight 16 lbs

✓
1617
x

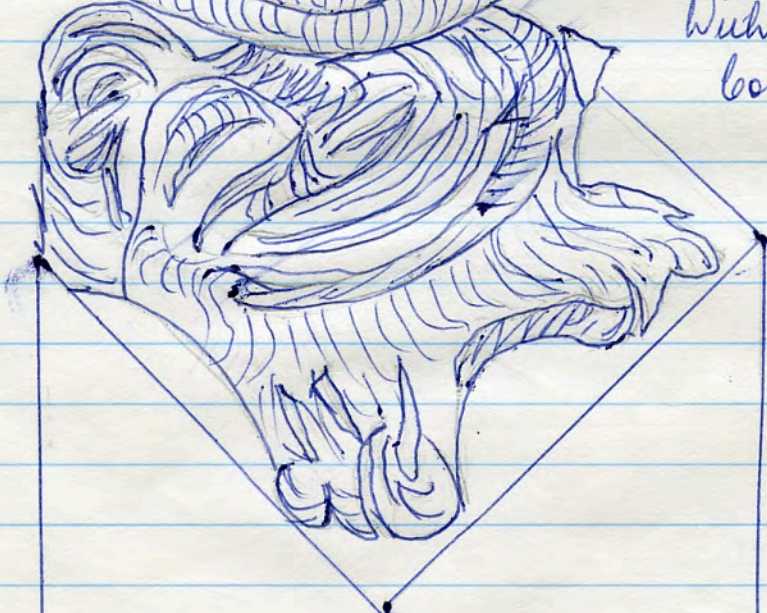

Widnell Bks & Terra
Cotta Co Ltd.

7. 9. 79.

Donated by Mr Langton (manager) at closure of bks wks

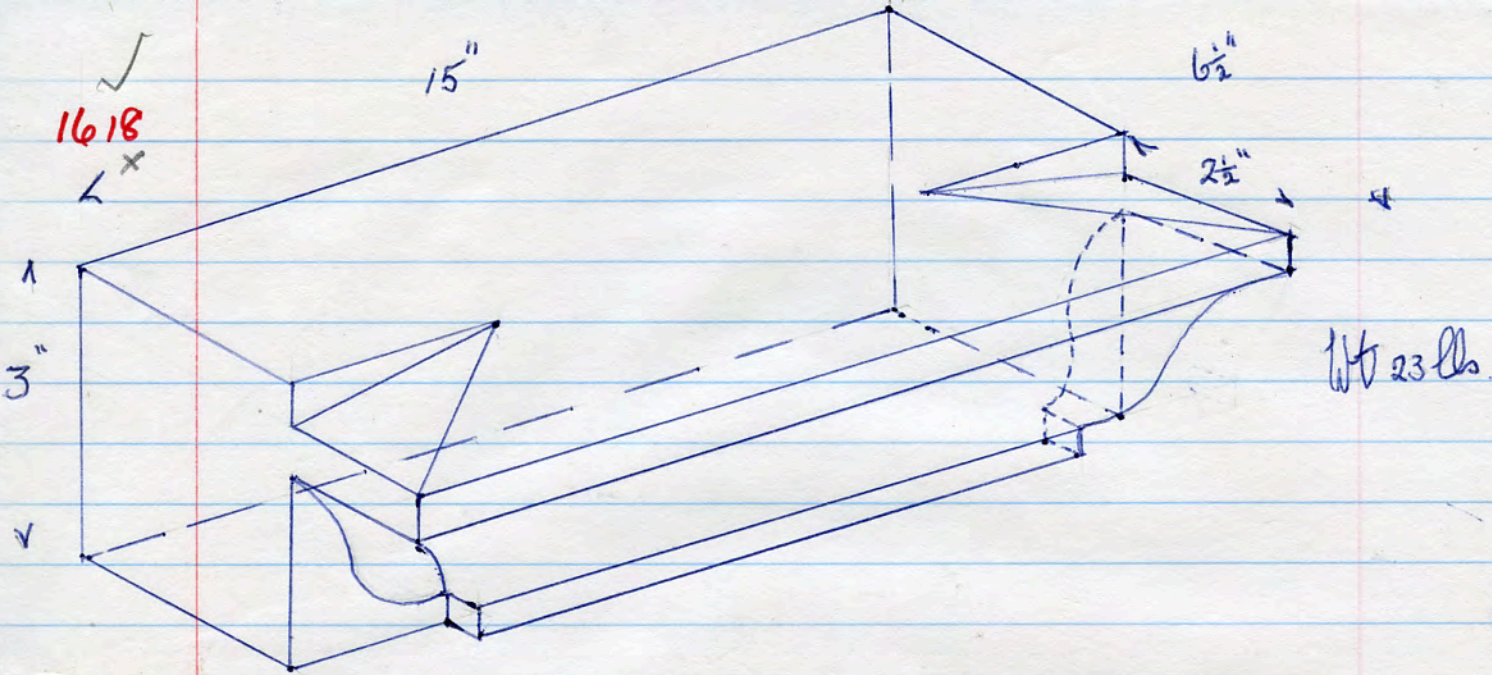

1618

As above - mould projection - $6\frac{3}{4}$ " 31 lbs.
 length $13\frac{1}{2}$ " x 3" x $11\frac{1}{4}$ " Wall hold $4\frac{1}{2}$ "

1619

1620

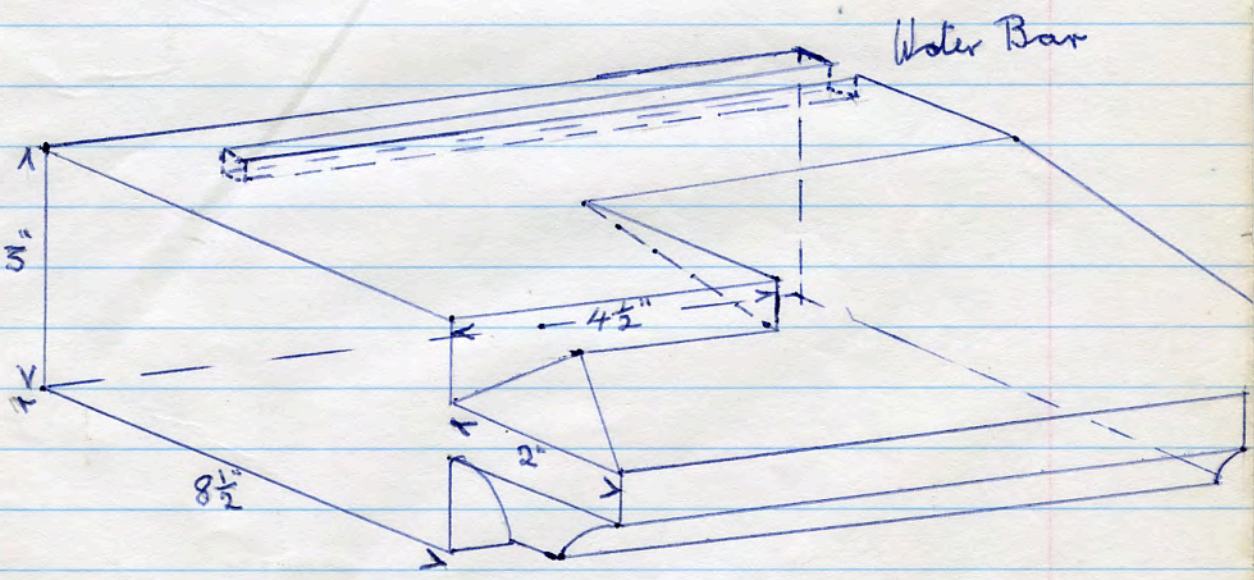

Wt 22 lbs

Sill piece.
 All above - Withnell Bk's Jensa better Co Ltd. 7. 9. 79

x 1621

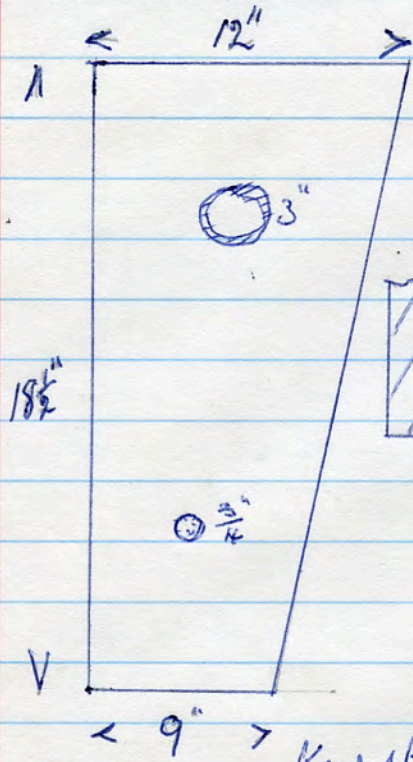

Section on A-A

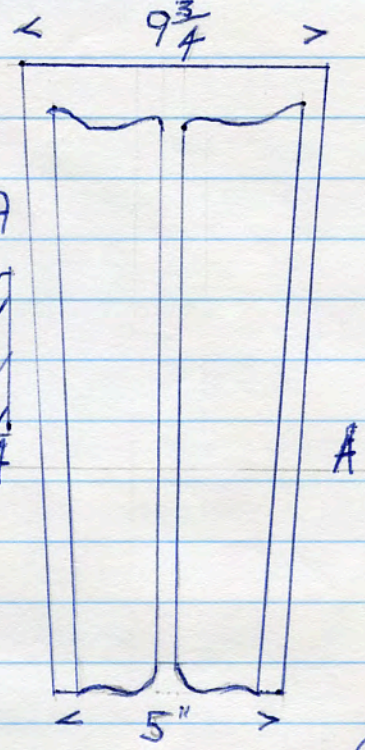
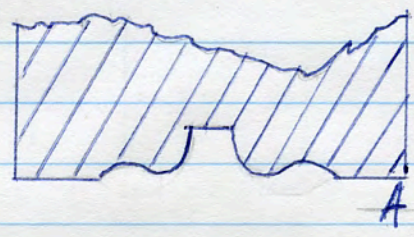

tile rolls

(18. 9. 79)

Key stone for arch.
Enfield Brk Wks - Display.

x 1622

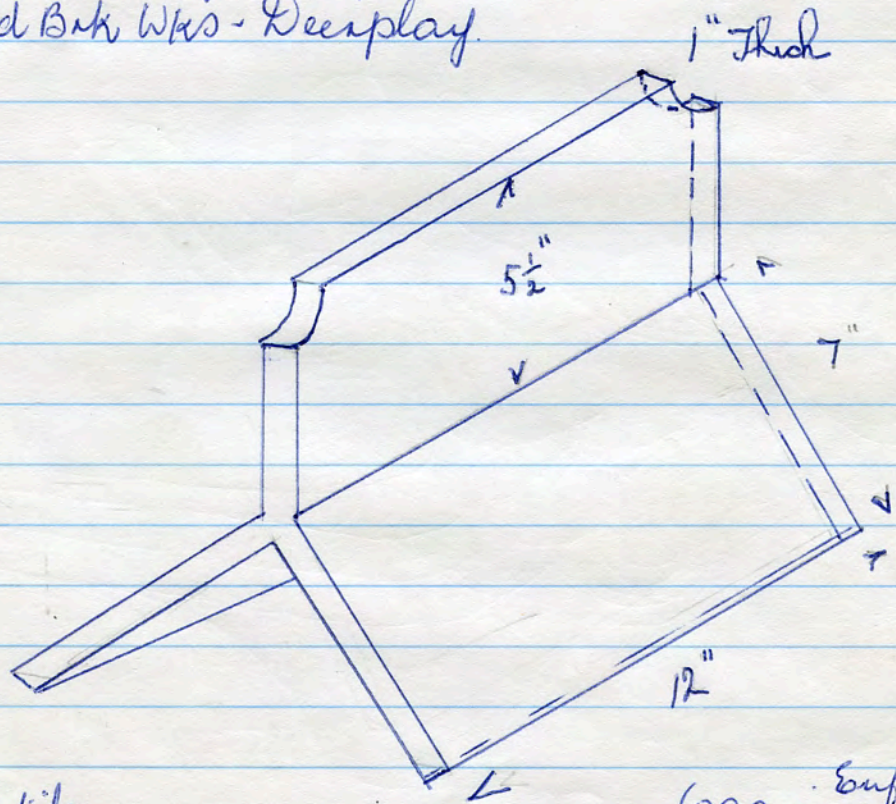

Ridge tile
Enfield Brk Wks - Display.

Enfield Brk & C. Co.
(290 in. catalogue)
(18. 9. 79)

X 1623 ✓
x

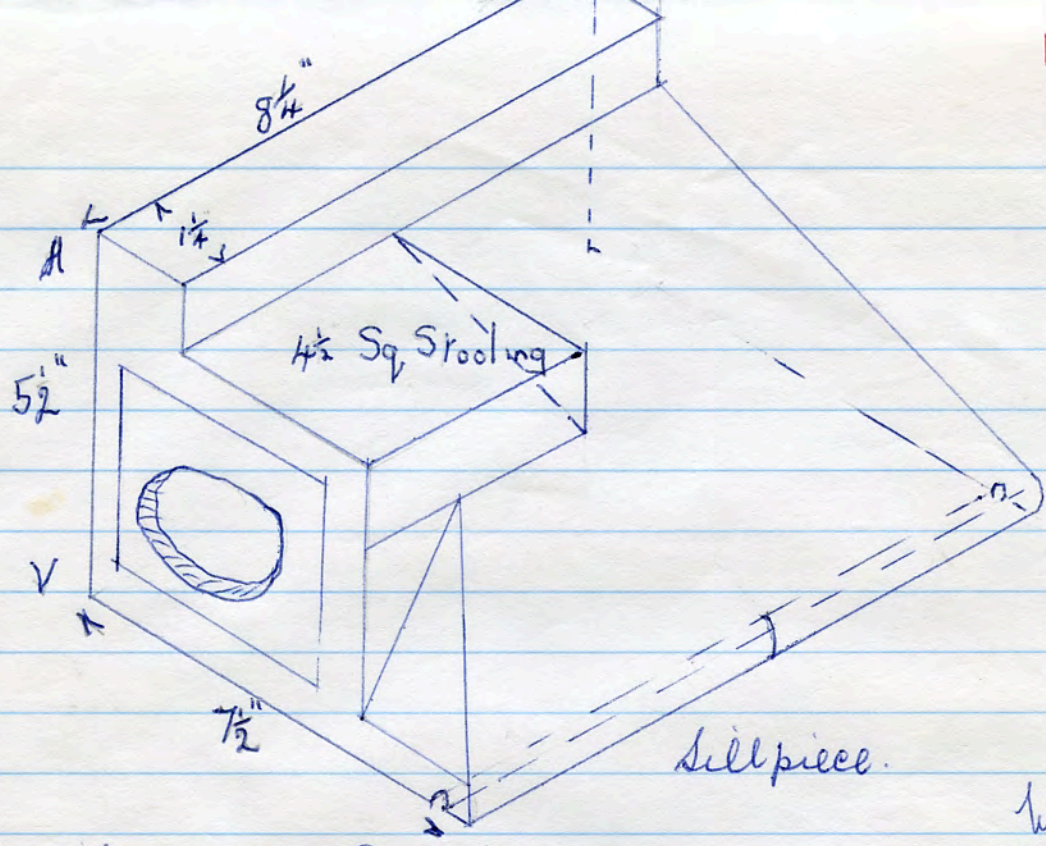

Enfield Bk Wks - Display

Wt 19 lbs.
(13. 9. 79)

✓
1624 x

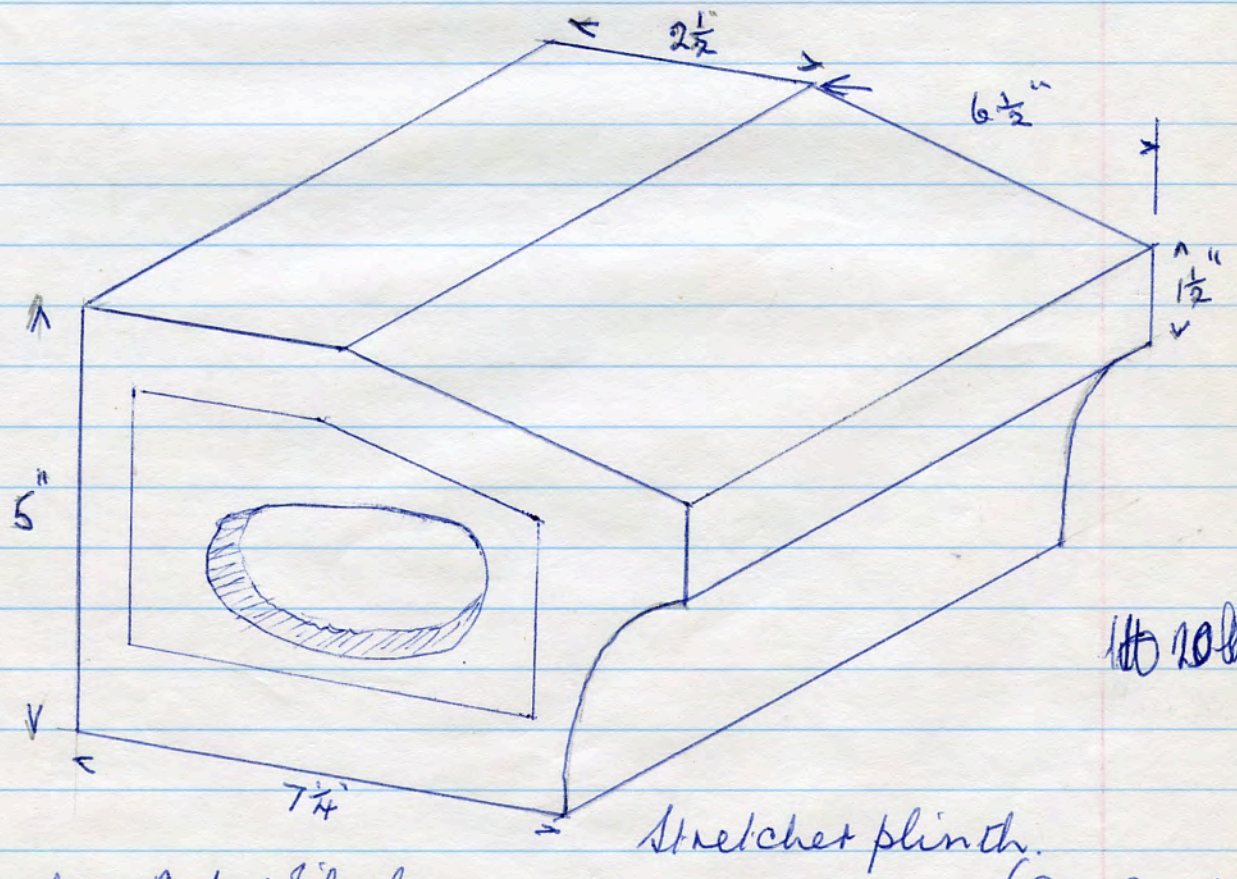

Stretch plinth.

Knaben Bk & Tile Co.
Ancoats - Aqueduct St. dem site.

Wt 10 lbs.

(9. 9. 79)

x 1625
x

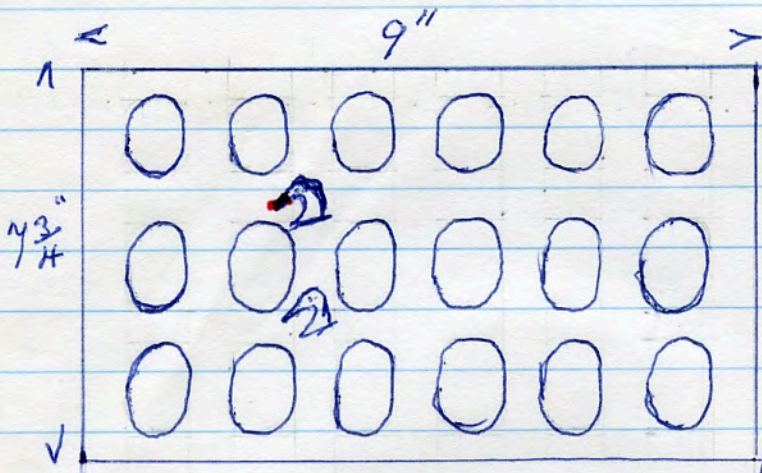

Vent Holes vary average
 $1\frac{1}{4} \times \frac{1}{2}$
 Carries the Raven Head Stamp
 $4\frac{1}{4}$ Deep. 16 lbs.

Ventilator brick
 (Ancoats mfr. 9. 9. 79)

1626
x

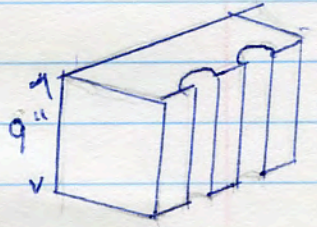
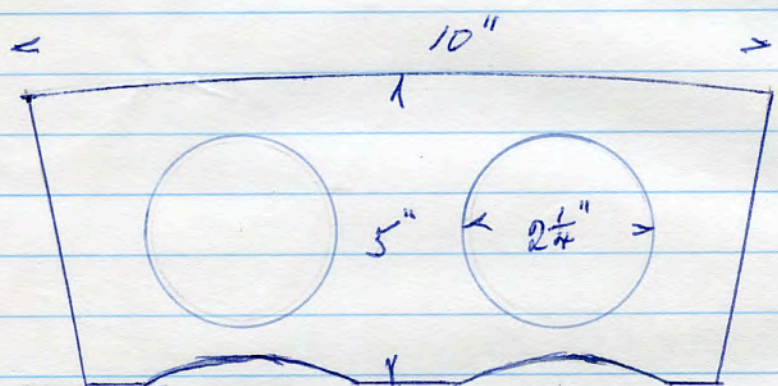

Wt 27 lbs.

Fine clay (cream) enucle brick. Elland 7. 10. 79.

6"
1627
x x

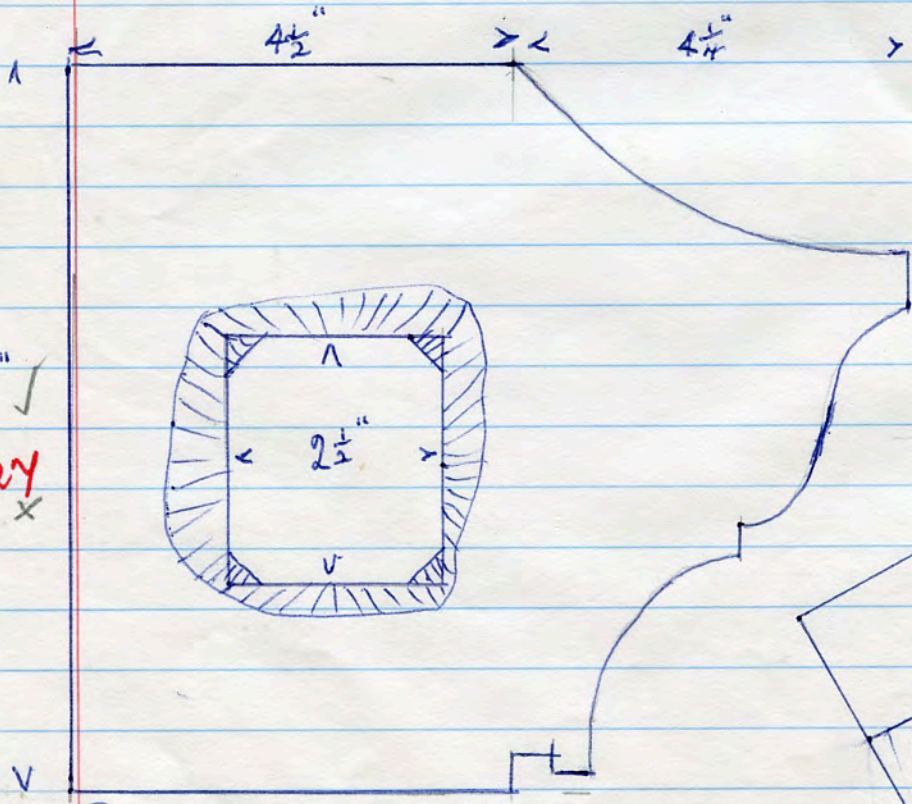

Wt 30 lbs.

Plan Sketch
 6"

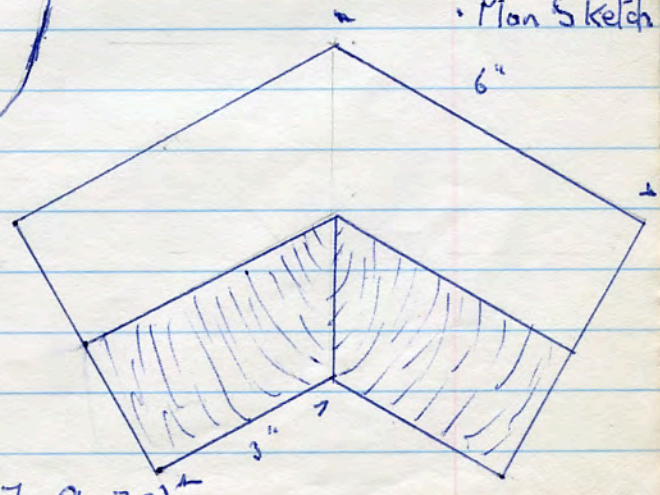

Decorative plinth
 (Withnell Bk & Terra cotta Co. 7. 9. 79)

One course moulded header
in red.

13 lbs.

x 165

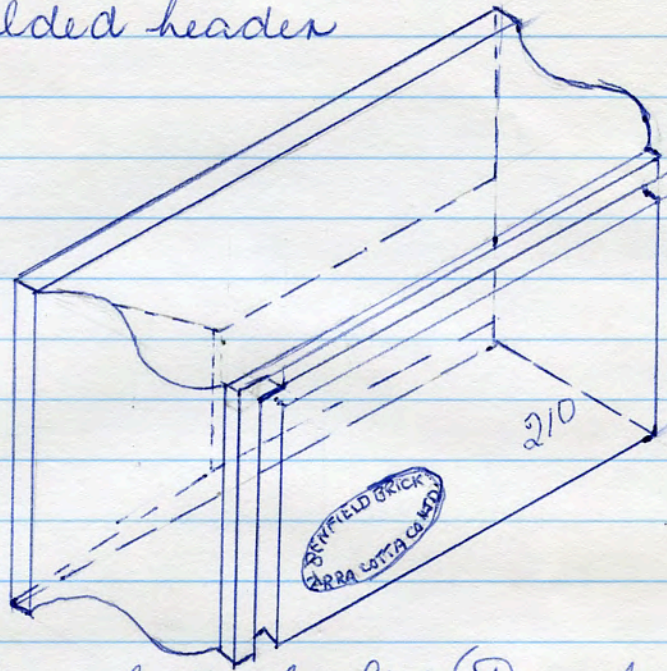

Enfield Brick & Terra cotta Co Ltd. (Display) 13. 9. 79

x 1650

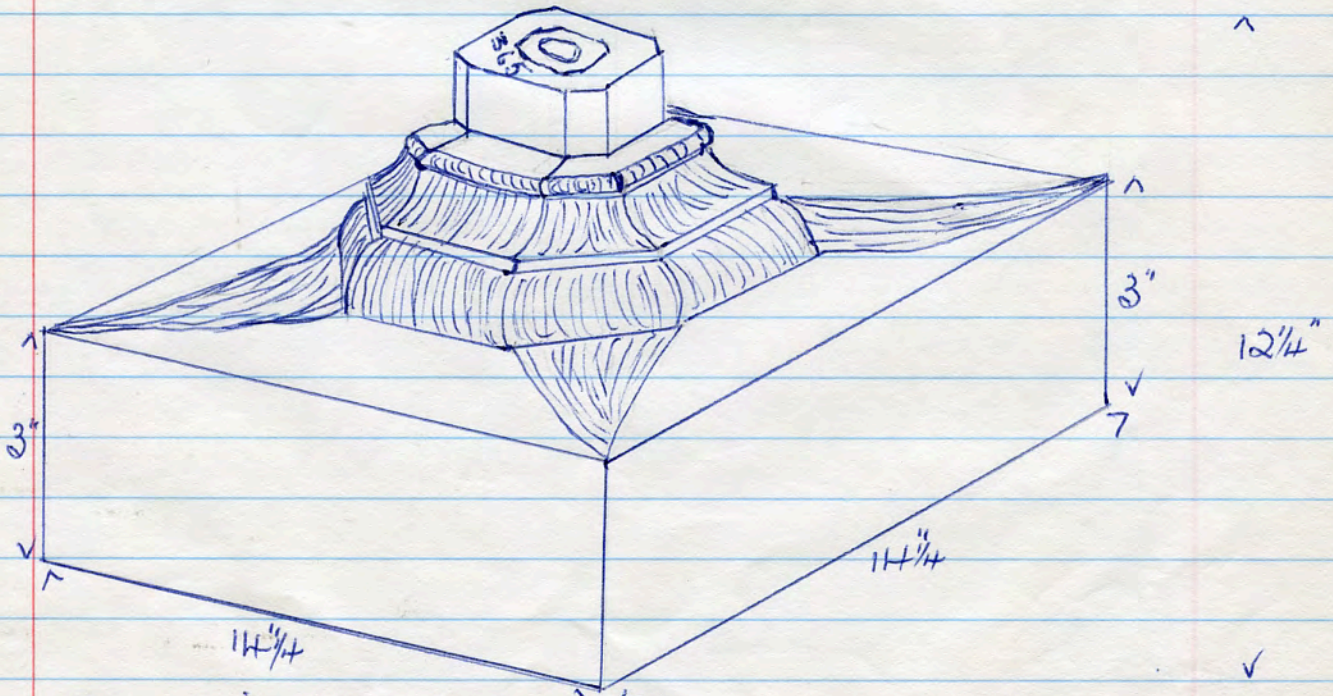

Gate pier cap in red.

Enfield Brick & Terra cotta Co. Ltd (Display) 13. 9. 79

Enfield Brick + Tile Co. Display. 31. 10. 79.

x1652

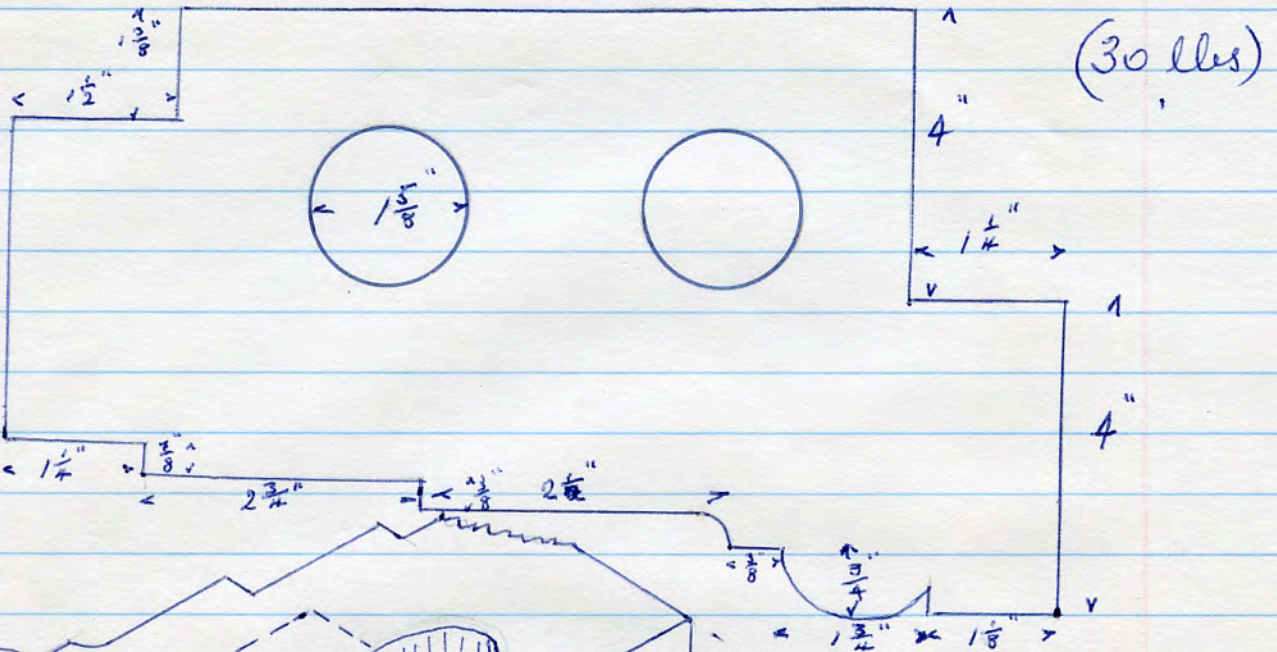

Decorative window side = 3 course bricks.

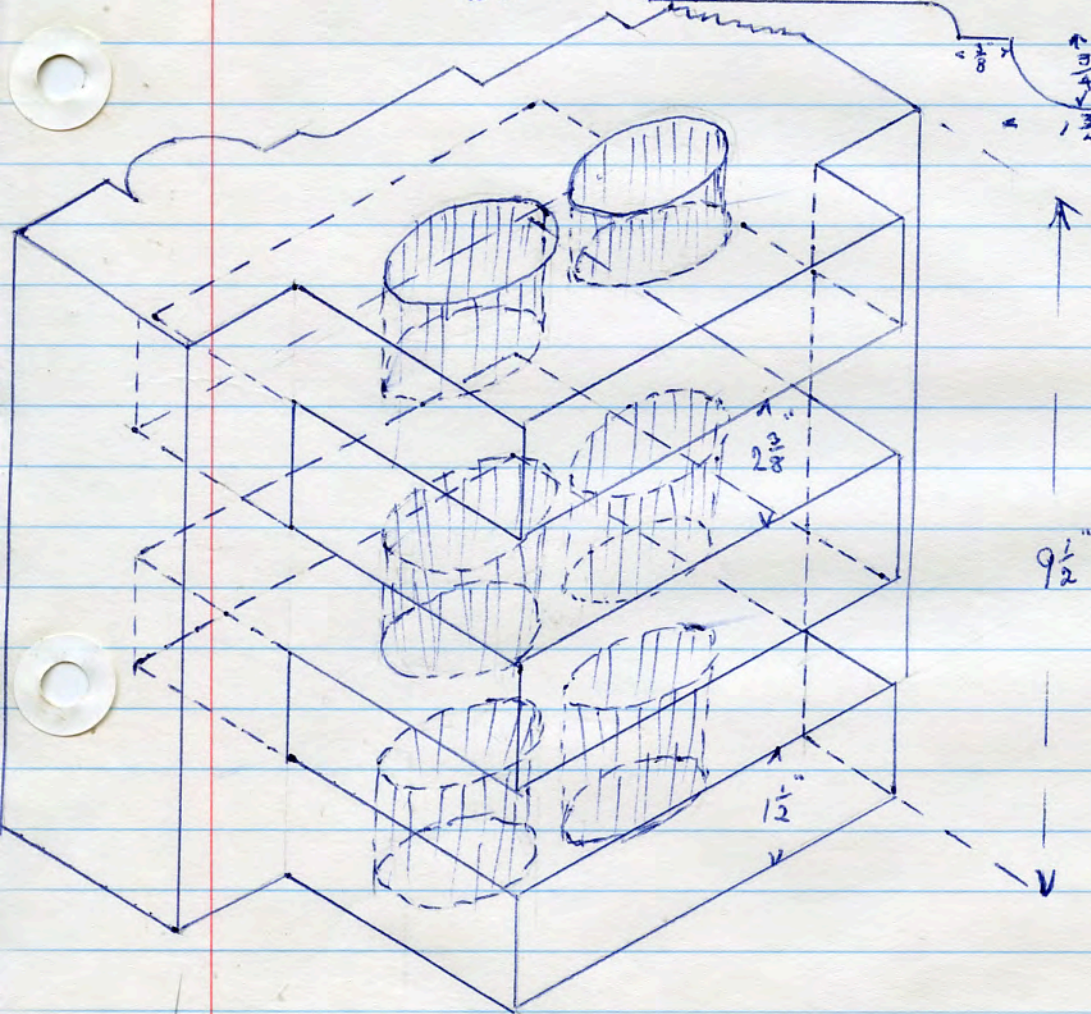

x1653

Gauged half brick for 1 3/2 gauged window head.

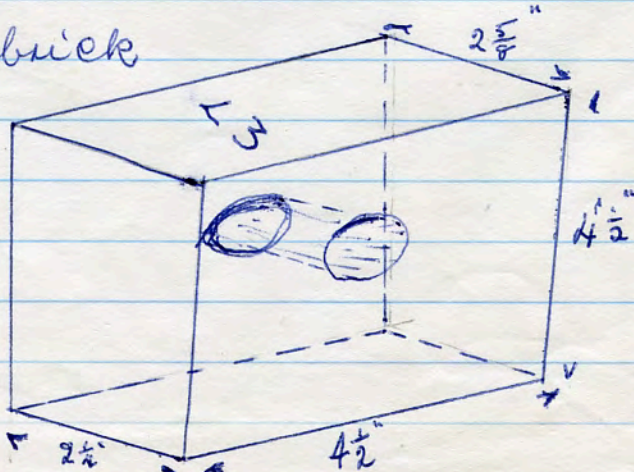

Enfield B + T Display.

✓
 1713^x floor tile - 9" x 4 1/2" x 3" black, blue.
 no name - made in Sheffield.
 15 perfs reverse, 1/4" diam. 5/8" deep.
 (Mrs Los. 1. 3. 80)

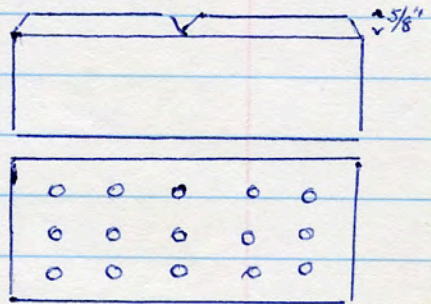

✓
 1721 ELUX 12-24 FRONT 7 3/16" x 5 1/2" x 2 3/16"
 electric storage heater block.
 found near to Morden Bk Wks at
 Rushlon. 8. 3. 80. letters incised.
 cream. groove on face only. 11 lbs.

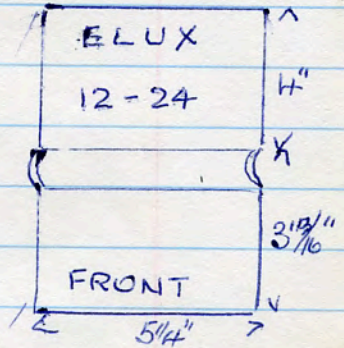

✓
 1724 WITHNELL BRICK & TERRA COTTA CO LTD PLASTIC 9" x 4 3/8" x 3"
 chamfered plinth brick, red.
 9 lbs. single panel, letters clearly incised
 Albert St Community Hall
 (built 1900) Gt Haswood.
 9. 3. 80

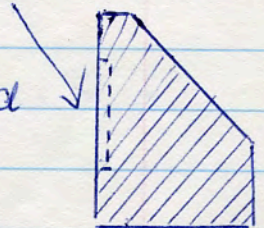
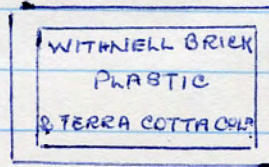

Hollow clay floor tile. No name, no panels.
 9" x 8 3/4" x 2 1/4". Roscudet run, wire cut. 14 lbs.

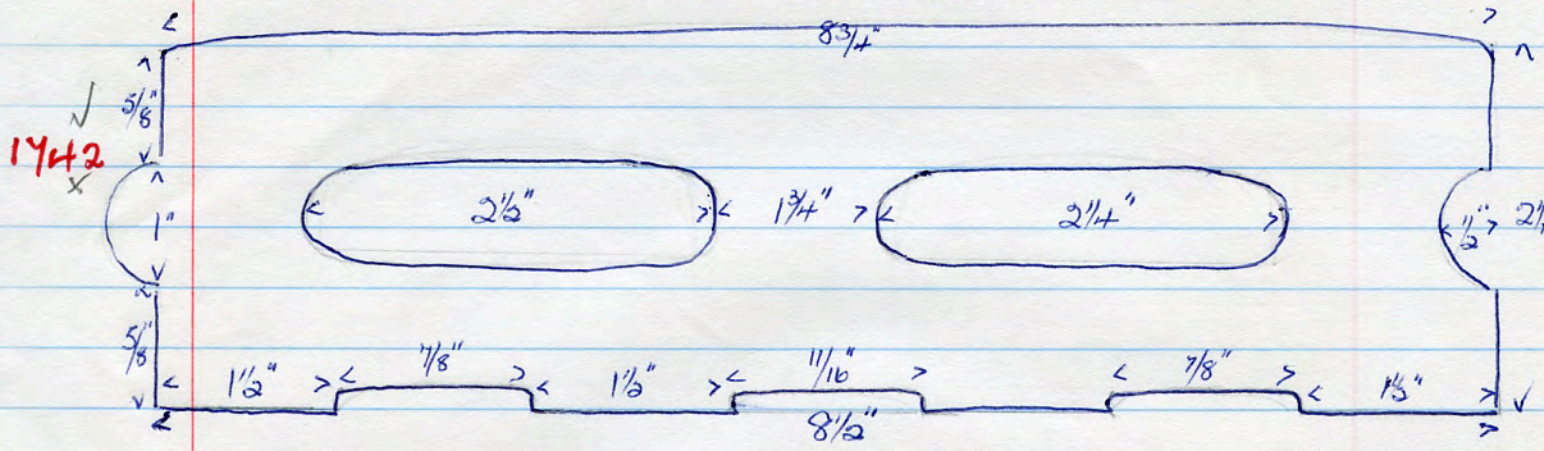

Rishton allotment: near to G. Clarke's kilns &
 fire clay works. 8. 3. 80.

Dec. sill piece.

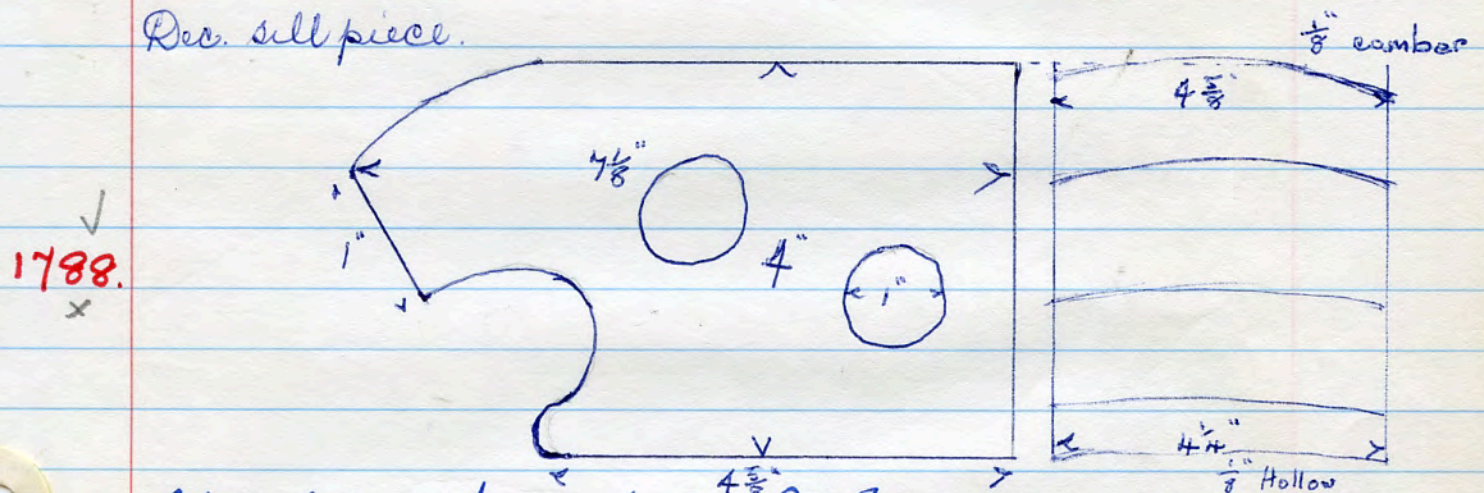

Chapel dem. Manchester Rd. Ince 13. 4. 80.

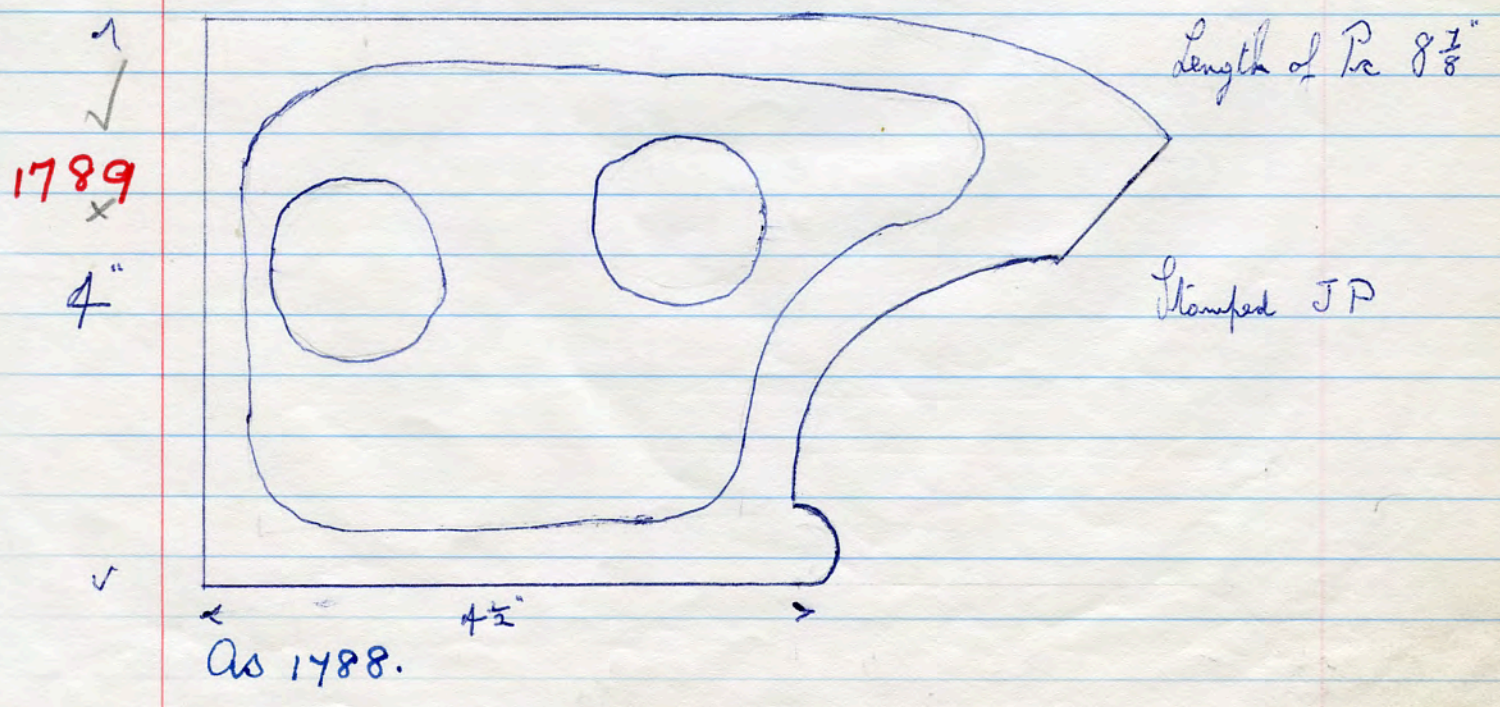

Length of Pa 8 7/8"
 Stamped JP

As 1788.

5 pieces of Terra cotta nos 1788 - 1792 are all products of JABEZ THOMPSON, ORNAMENTAL BRICKWORKS NORTHWICH

Stamped STK 36

16 Y 3

1790

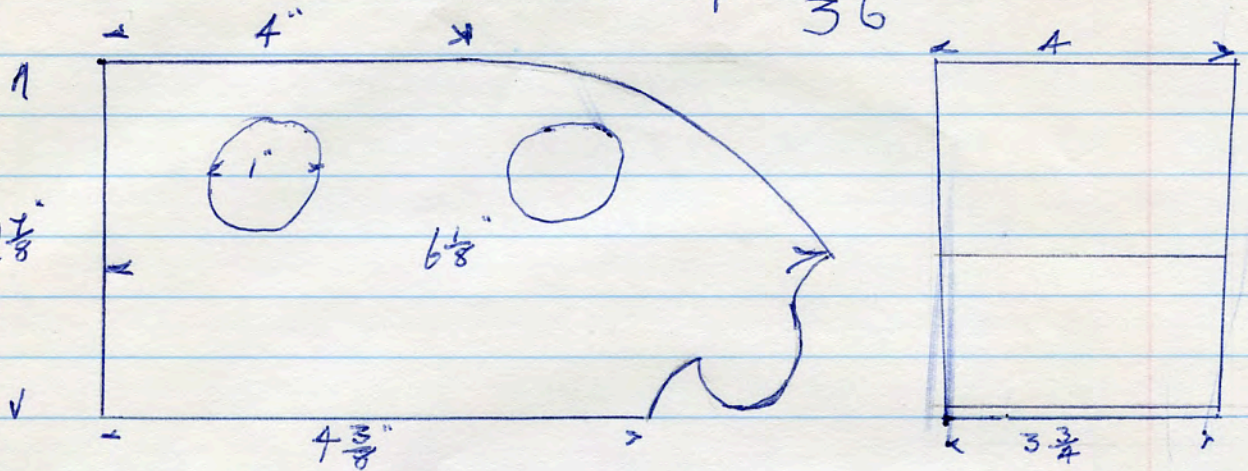

Chapel dem. Manchester Rd, Ince 13. 4. 80.

1791

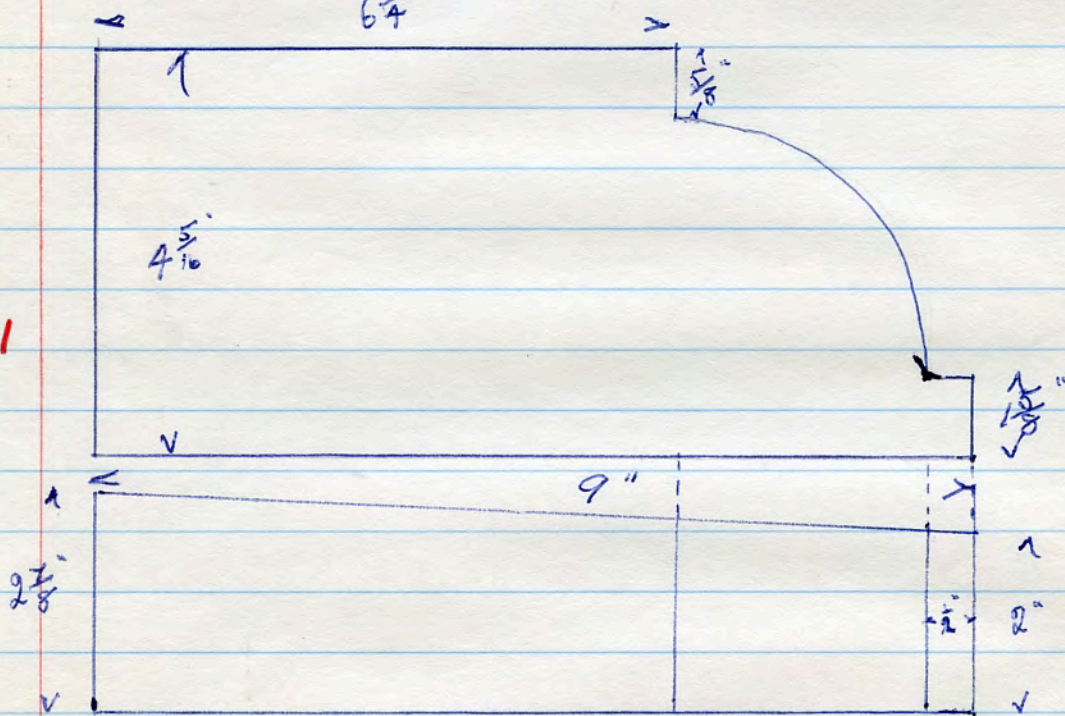

As 1790

1792

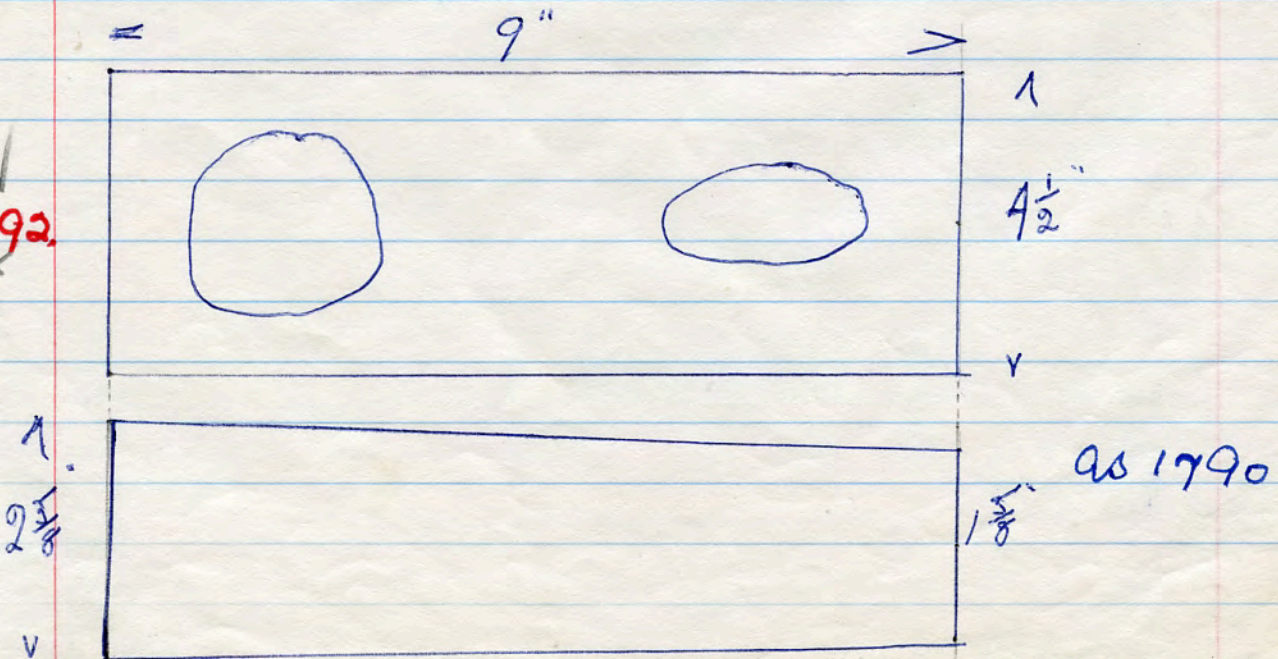

as 1790

✓
 1793 x No name, no panels. 2 1/8" deep.
 cream fireclay corbel, ornamental
 chapel dem. Manchester Rd. Ince. 13. 4. 80.

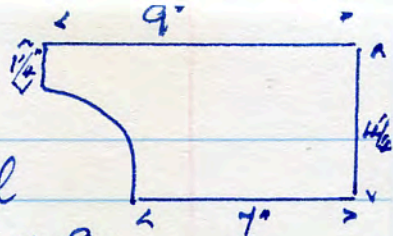

✓
 1794 x Gauged arch brick in cream fireclay, as above.
 16 3/4" x 4 3/8" x 3" - 2"

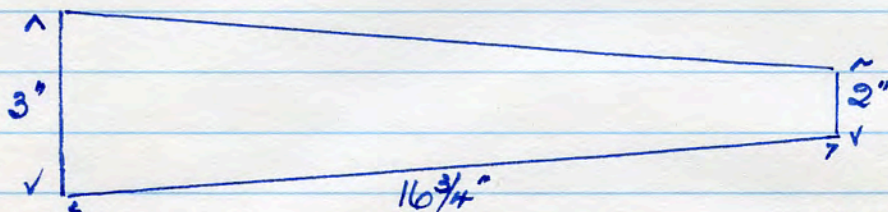

3" deep.

JABEZ THOMPSON NORTHWICH
 small decorative terra cotta block.
 panel on face side containing cross
 name stamped on 1 edge.

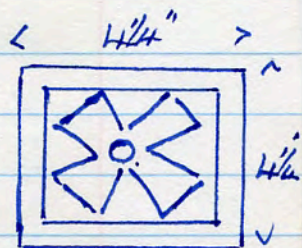

✓
 1795 x circular frog on reverse 3" diam 1/4" deep.
 chapel dem. Manchester Rd. Ince. 13. 4. 80.

No name, no panels.
 Decorative string course brick with
 floral motif. 9" x 4 1/2" x 3"



House & shop dem.
 Sovereign Rd. Wigan
 13. 4. 80.

✓
 1796 x

1811 x

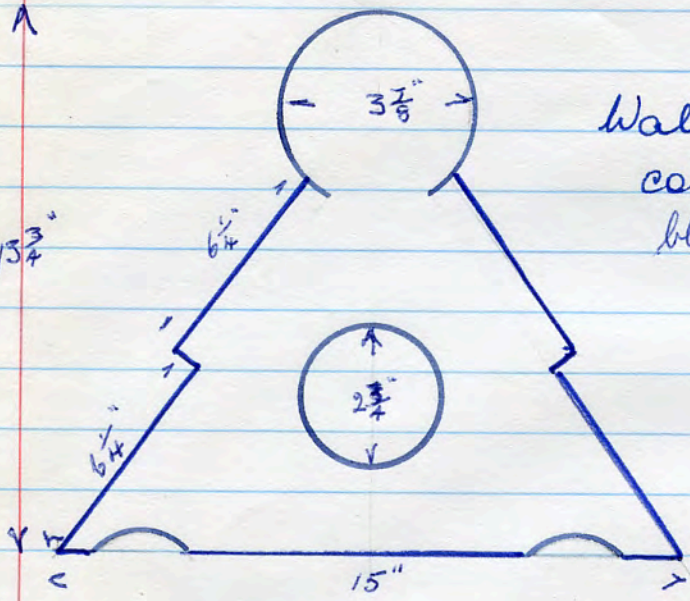

Thickness $3\frac{3}{4}$ " Wt. 25 lbs.
 Wall capping, Ladyshore, old
 colliery buildings, little lever.
 blue 13. 4. 80.

1812 x

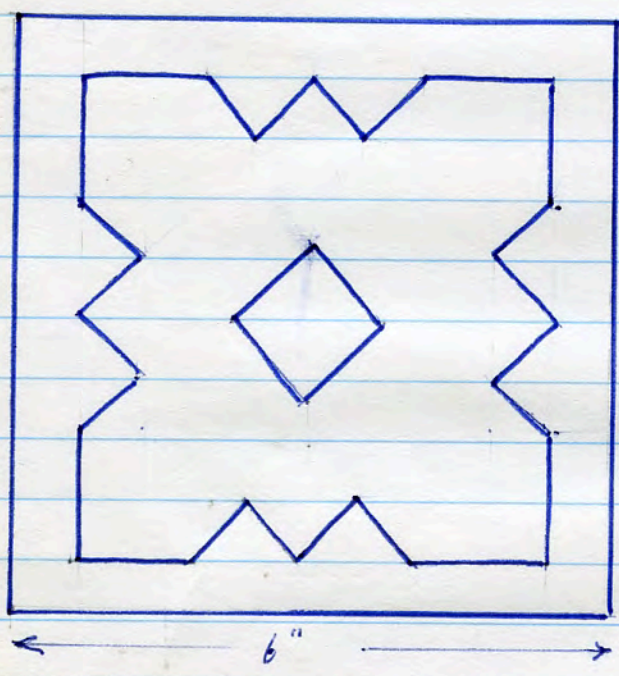

Thickness $1" \times 6" \times 6"$ Wt. 2 lbs.
 Pair of quarry tiles
 1 red 1 blue.
 Swan Island, site of old
 brick works, Hindsford
 as Atherton. 13. 4. 80.

1813 x

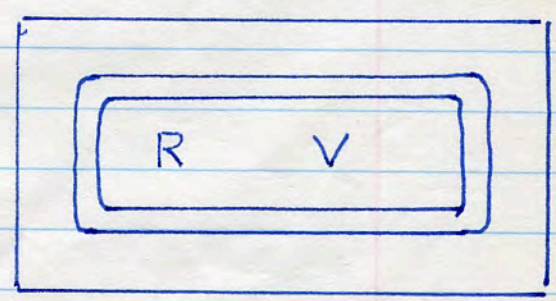
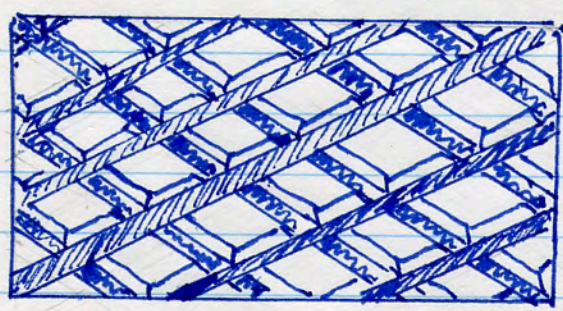

Blue paving, single panel rev. letters in relief.
 $9" \times 4\frac{1}{4}" \times 2"$ 5 lbs.
 Swan Island, Hindsford, Atherton. 13. 4. 80.

1825 x

x

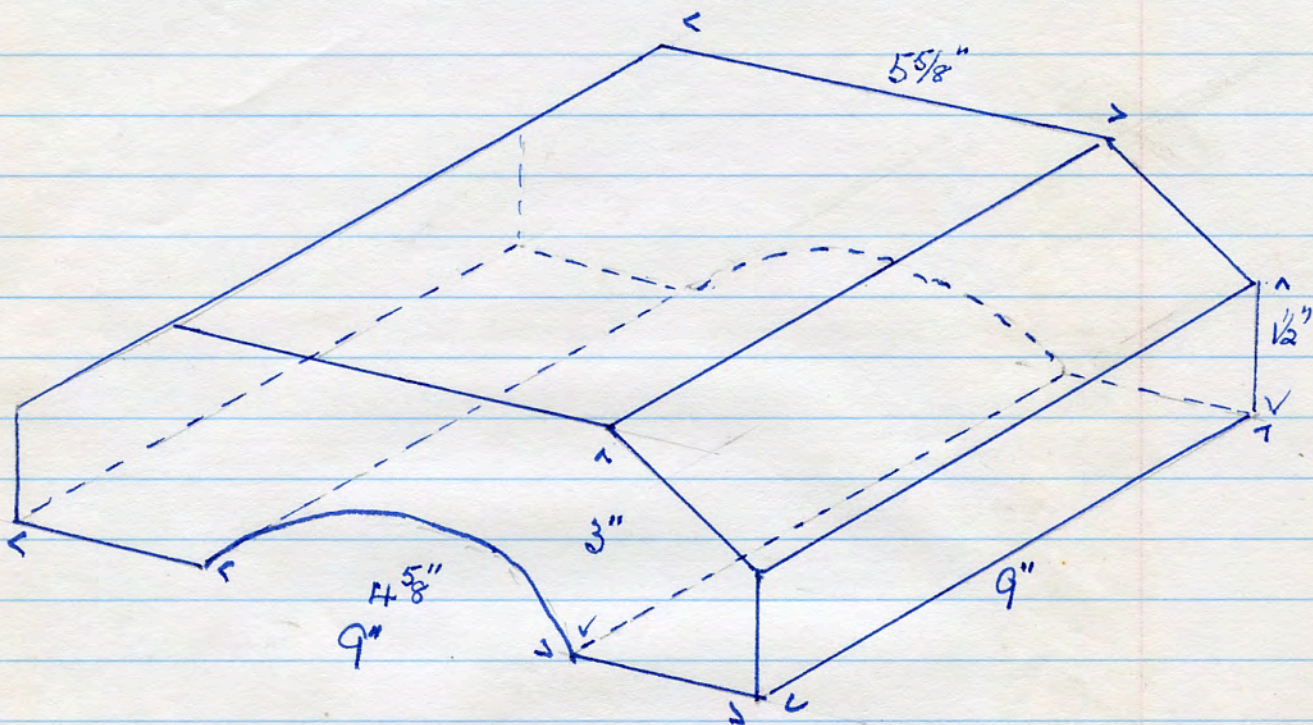

Blue wall capping. No name, no panels
14 lbs.

Guide Street, house dem. Waste. 27. 4. 80.

No name. Guinamon coloured clay piece.

12" x 4 1/16" x 4 1/2" - 3" 10 lbs

1855 ✓
2 perfs. throughout length. 2 1/8" x 1" - 1/8".
groove on 1 edge, tongue on the other
Ondsaal - site of "dig" of 13th farmhouse.



RUABON BRICK TERRA COTTA CO L^D S L

1856 ✓
decorative string course brick. 9" x 4 1/8" x 3 1/8"
3 flowers. single panel rev. incised
letters except S. L in relief. 8 lbs.
Guide St dem. Weaste. 4. 5. 80.

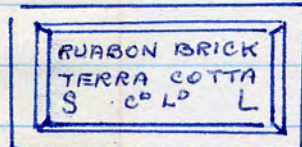

PLATT'S OP BCM/DF&S HAND MADE

1857 ✓
6" x 6" x 7/8" 2 lbs. ENGLAND

decorative panel rev.
Mrs. Hos 30. 9. 49



No name. 14 holed ventilator brick.

1858 ✓
8 5/8" x 3" x 2 1/4" 3 lbs

Guide Street dem. Weaste 4. 5. 80.

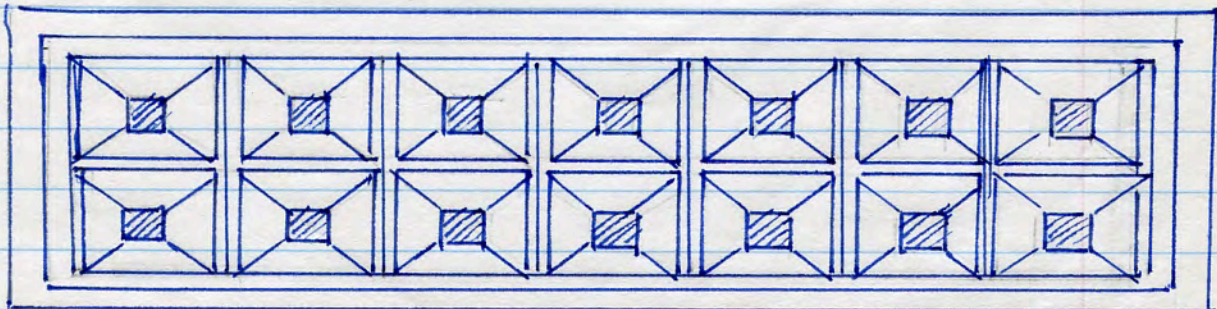

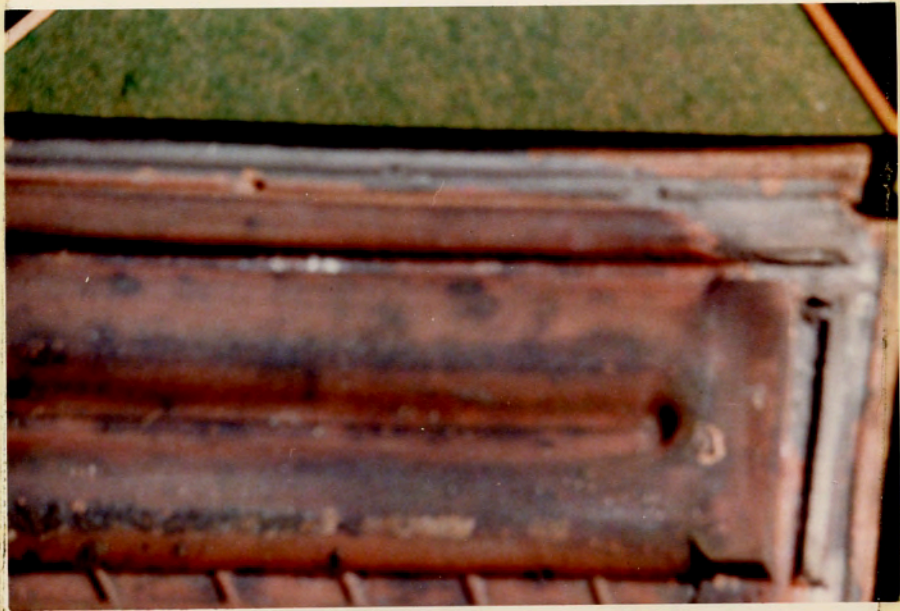

no name, no panel. 6 lbs.
Decorative terra cotta window sill

7 1/2" x 4 1/4" x 2 7/8"

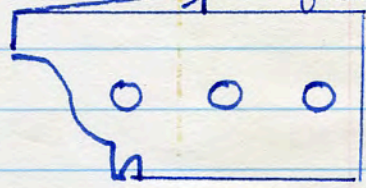

cement add/n
to create a
fillet for water
protection

1868 x
x

3 perfs 7/4" diam.
Mrs Ros. 11. 5. 80.

no name, no panel 8 7/8" x 3" x 2 5/8"
Ventilator 4 lbs. Ancoats

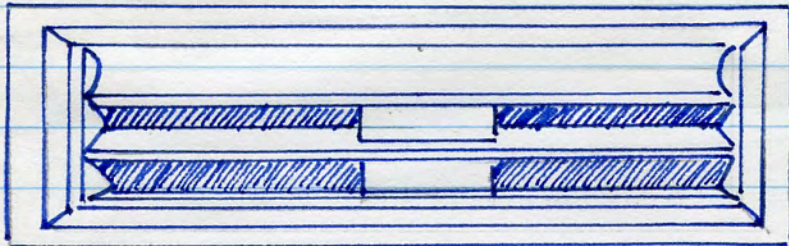

1869
x x

380

THE SOMERSET TRADING CO LD BRIDGWATER
red clay roofing tile 16 1/8" x 9 1/2" x 6 lbs.

1870 x

Ladyshore, little lever (lead mark)
13. 4. 80.

QUICHARD FRERES SEON ST HENRI MARSEILLE.

1871

red clay roofing tile 6 lbs. (lion mark & B M(?))
Ladyshore, little lever. 13. 4. 80.
see foreign. 5F.

1894 x Garden edge tile, no name
mottled (should be blue)
7" x 7" x 7/8" 2 1/4 lbs.
Guide St dem. Weastli 27. 4. 80.

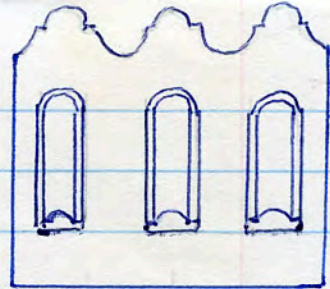

1933 x No name. 9" x 6 1/2" x 3 1/4". 14 lbs
terracotta moulded stretcher.
braintree Lane, Drayliden, 15. 6. 80.

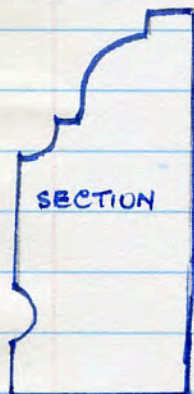

1934 x No name. 42 moulded header,
terracotta. Stamped 1 side.
no panels. 9" x 4 1/2" x 3" 10 lbs.
pressure hole in centre base,
braintree Lane, Drayliden, 15. 6. 80.

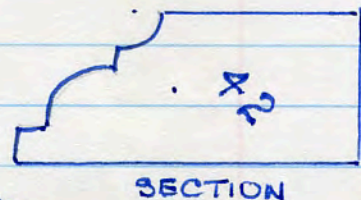

1935 x No name. moulded header
1" deep frog in each side
can be used in either vertical
or horizontal work. 9 lbs.
terracotta. 9" x 4 1/2" x 3 1/4"
Wilton Street dem. Wigan. 1. 6. 80.

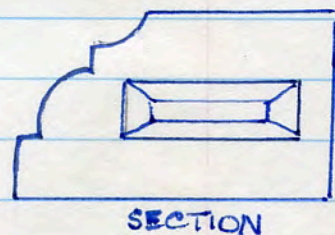

1936 x No name. terracotta, ^{small stretcher with} moulded return end.
6" x 6 1/4" x 3 1/8" 8 lbs.
no panels
Wilton Street dem Wigan 1. 6. 80.

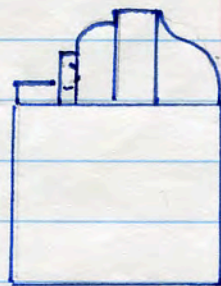

1937*
 R P C red, 8 lbs. moulded header
 single panel 1 side only.
 letters incised. 9" x 4 1/4" x 3"
 Sovereign Rd. dem. Wigan 1. 6. 80.

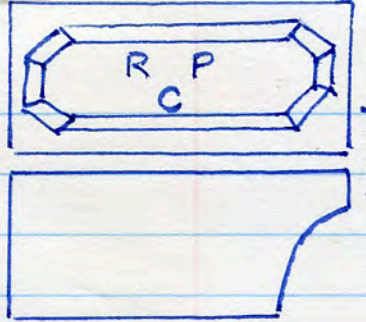

1938*
 H C P red 8 lbs. moulded header.
 single panel 1 side only.
 letters incised. 8 7/8" x 4 1/8" x 3"
 Sovereign Rd. dem. Wigan 1. 6. 80.

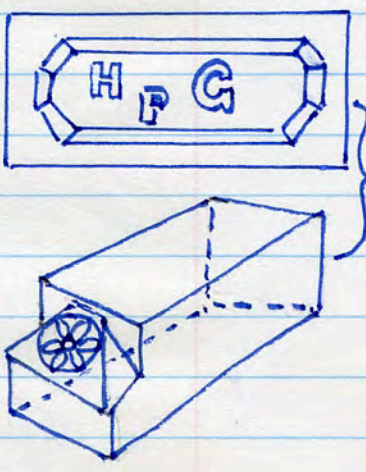

1939*
 No name. red 9" x 5 3/4" x 2 3/16". 12 lbs.
 moulded stretcher, terra cotta.
 single panel 1 side only.
 Sovereign Rd. dem. Wigan 1. 6. 80.

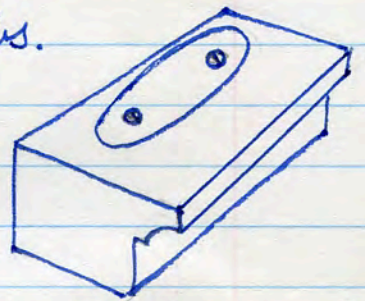

1940*
 JABEZ THOMPSON TERRA COTTA WORKS NORTHWICH
 dec. terra cotta stretcher.
 7 lbs. 9" x 4" x 3".
 single 1/2" deep panel rev.
 name stamped 1 side
 Sovereign Rd. dem. Wigan 1. 6. 80.

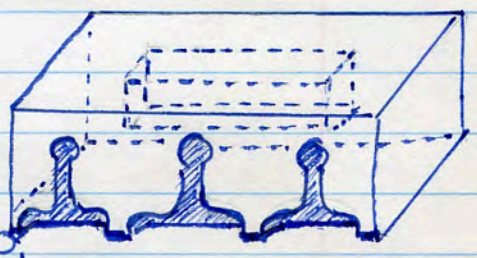

1941*
 JABEZ THOMPSON TERRA COTTA WORKS NORTHWICH
 terra cotta gauged arch brick.
 6 lbs. 8 7/8" x 3" - 1 3/4" x 4 3/8"
 name stamped 1 side.
 3 perfs □ 1 1/2" x 1 3/4"
 Sovereign Rd. dem. Wigan 1. 6. 80.

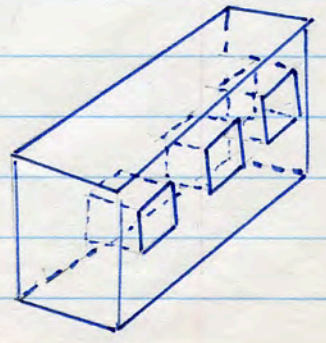

No name, red clay dec. stretcher.

8 lbs. 9" x 4 3/4" x 3 3/4"

no panels.

Sovereign Rd. dem. Wigan. 1. 6. 80.

1942 x
x

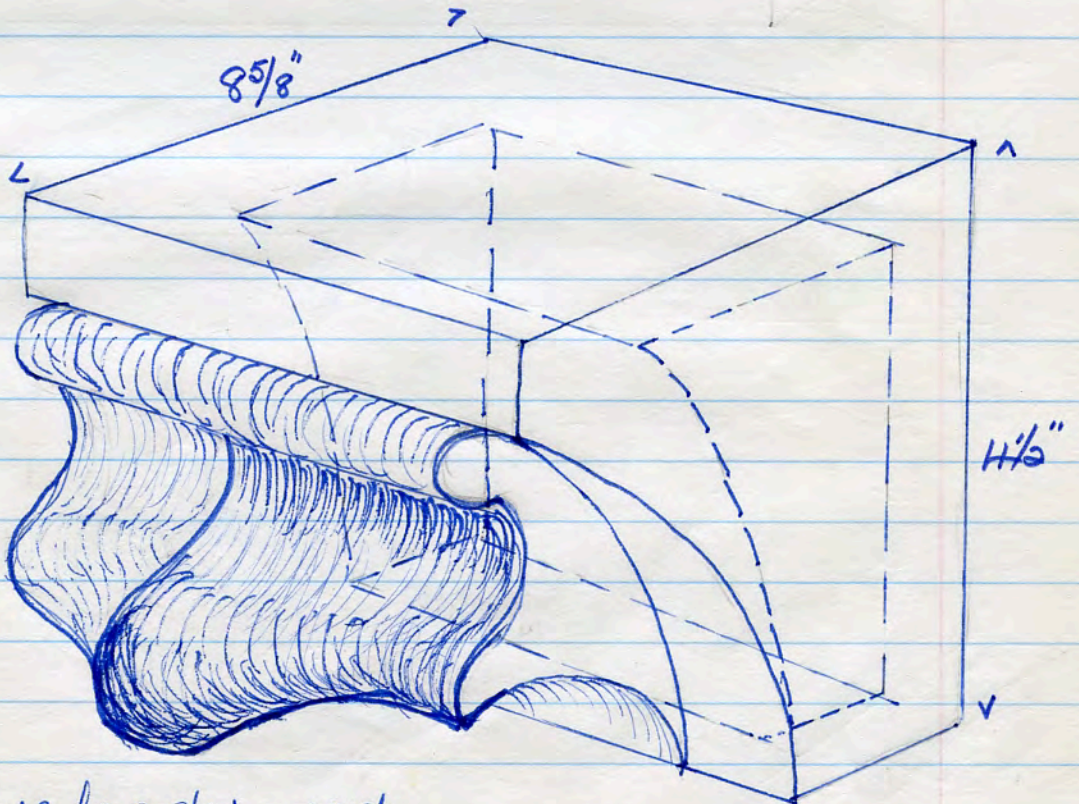
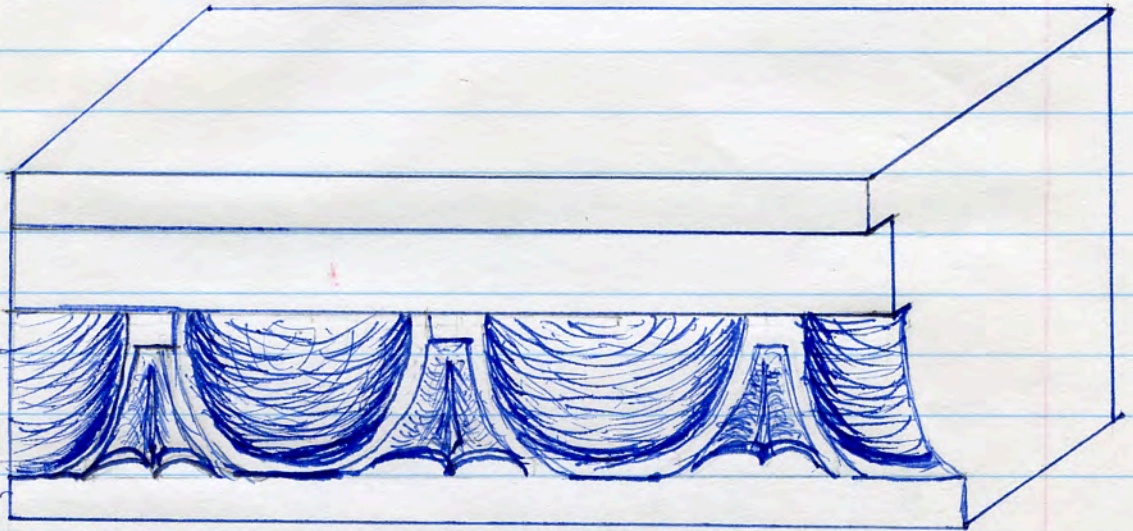

1943.
x
7

Decorative header, red

~~4 1/2"~~ 4 1/2" x 4 1/2" x 8 5/8"

large roughly shaped panel. shows finger marks

no name (presumed stamped) JABEZ THOMPSON. 2 1/2" x 2 1/2" x 6"

TERRA COTTA WORKS NORTHWICH.
Sovereign Rd dem. Wigan. 1. 6. 80

£ incised inside frog (moulder's stamp).

D A B. terra cotta door or window pilaster brick.
6 1/2 lbs. 6 3/4" x 6 1/2" x 3" 2 O perfs 1 1/4" diam.
Sovereign Rd dem Wigan 1. 6. 80.

1947
x



letters incised

1948
x

No name. no panels. 3 lbs 6 1/2" x 3"
terra cotta string course (part brk).

Sovereign Rd. dem. Wigan
1. 6. 80.

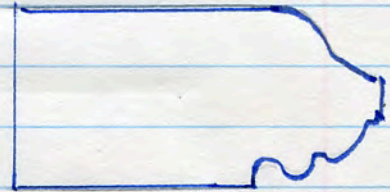

1949
x

JABEZ THOMPSON TERRA COTTA WORKS NORTHWICH.
terra cotta quadrant + scotia mould with
water drip, return stretcher mould.
2 x 1 1/4" diam. fixing holes. tapering to 5/16"
name stamped on 1 end. 7 lbs. 7" x 6 3/4" x 3 1/8"
Sovereign Rd. dem. Wigan. 1. 6. 80

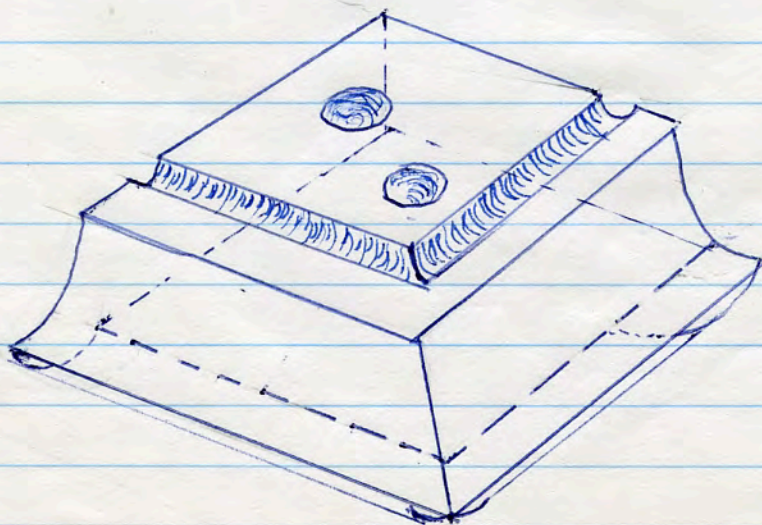

✓
1950
x x

JABEZ THOMPSON TERRA COTTA WORKS NORTHWICH
terra cotta wall capping. name stamped on base.
10 1/2 lbs. shows finger marks inside.

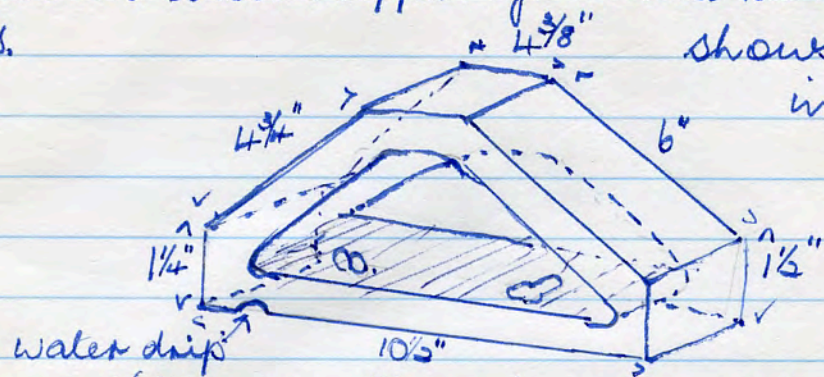

Dem. opp. Victoria Rwy Station W/A. 15. 6. 80.

✓
1951
x x

J1363 ◊ (J. L. Edwards, Ruabon).
terra cotta quadrant moulded stretcher.
numbers stamped on base.

single 5" x 2 1/4" x 3/4" panel in base.
9" x 6 1/2" x 3/4" 14 lbs

David Lewis Home dem. L/pool
8. 6. 80.

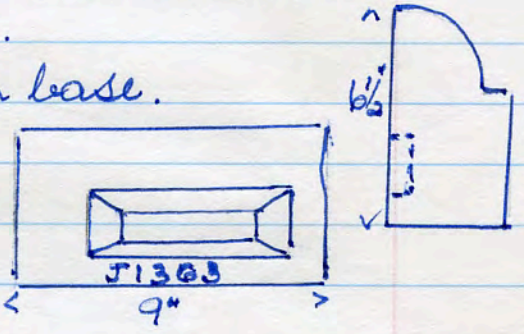

✓
1952
x x

Q 26 □ (no name - presume J. L. Edwards).
terra cotta parapet cover. 42 lbs 11 3/4" x 13" x 6"
single shallow panel each end. letters & nos incised
2 large hollows inside 7" x 4 1/2" x 4"

David Lewis Home dem. L/pool. 8. 6. 80.

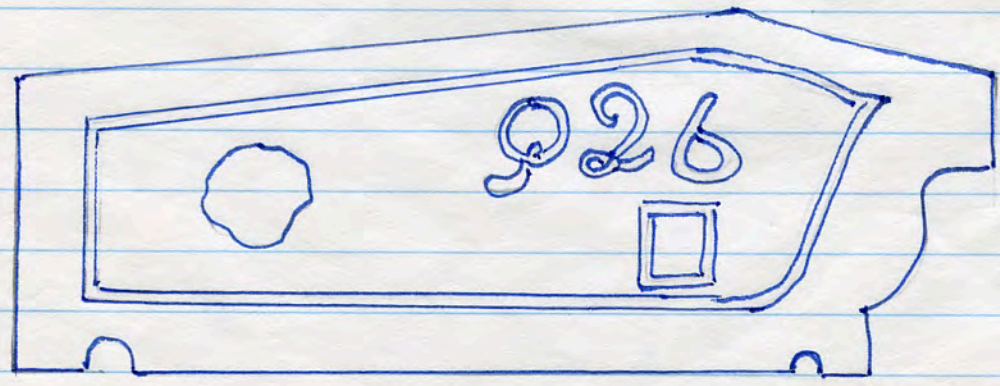

◇ J 812 (J. L. Edwards - presumed) 17 lbs.

terra cotta door or window surround $10\frac{1}{4}" \times 6\frac{1}{2}" \times 6\frac{1}{2}"$

✓
1953
x*

single shallow panel each end, letters to be incised
2 large cavities $3\frac{1}{2}" \times 3\frac{1}{2}" \times 3\frac{1}{2}"$

David Lewis Home dem. L./pool. 15. 6. 80.

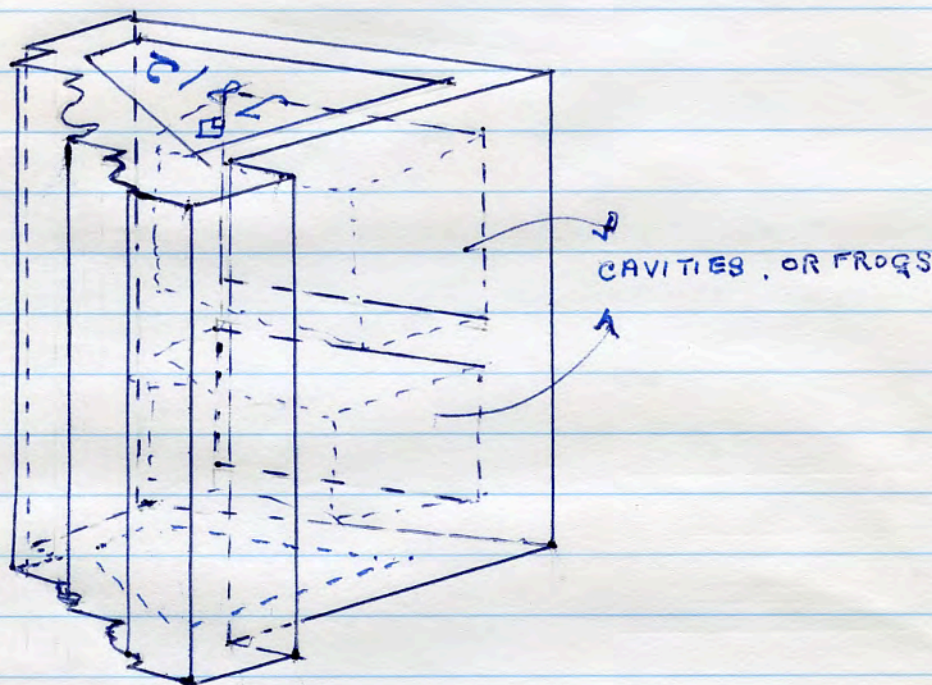

J 835 □

2 terra cotta gauged arch or door bricks.

$11" \times 3" - 2\frac{1}{4}" \times 5\frac{3}{4}"$ 19 lbs (2).

✓
1954
x*

no panels. 2 large perfs.

David Lewis Home dem.

L./pool. 15. 6. 80.

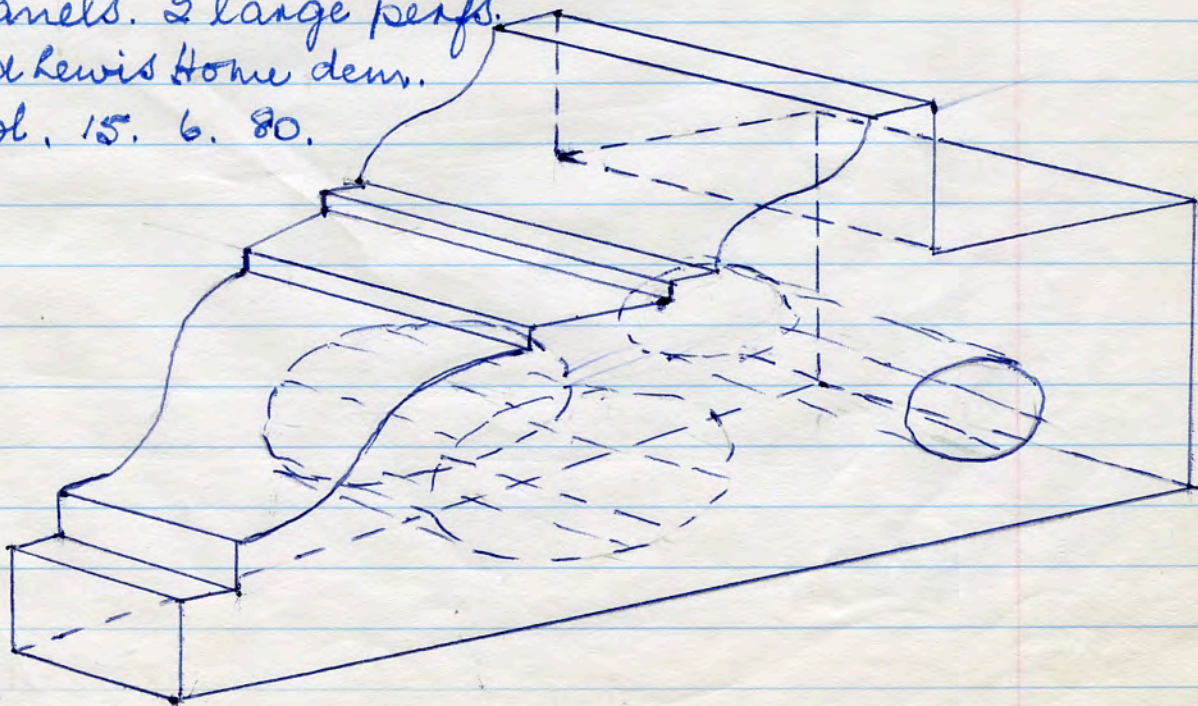

J 621 [] (J. K. Edwards)

terracotta moulded dec. pier brick.

7 lbs. 8" x 5 1/16" x 3 1/4" no panels. letters incised (faint).
1 perf. (through) 1 1/2" diam.

David Lewis Home dem
L/pool. 15. 6. 80

✓
1955
x x

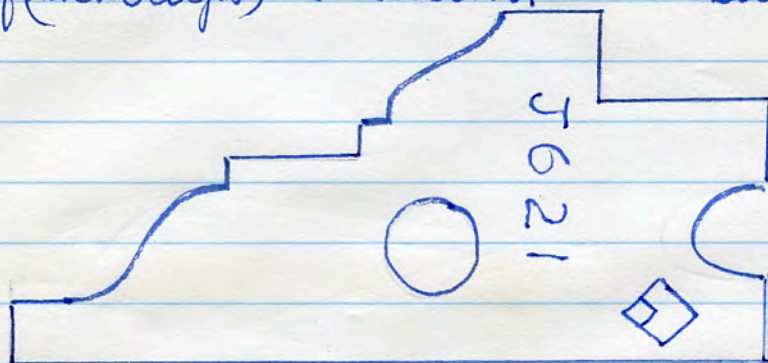

J 822

terracotta moulded dec. pier brick

7 lbs. 9" x 4 3/4" x 3 1/2" no panels letters incised
1 perf. (through) 3" x 1 1/4" structure.

✓
1956
x x

Garth iron built in 1 3/4" x 1/16" - known as garth iron -
David Lewis Home dem. L/pool. 15. 6. 80.

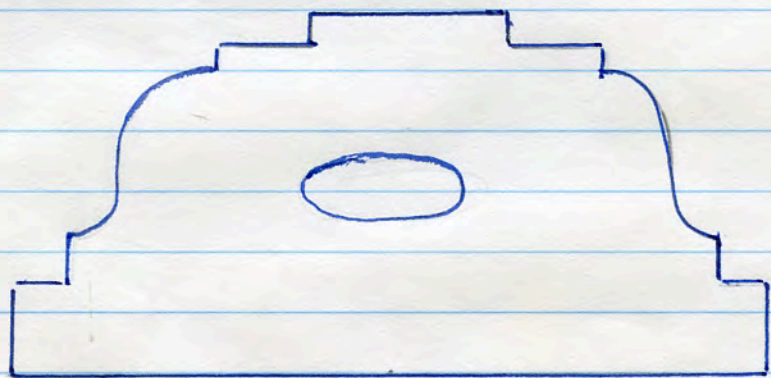

No name. terracotta finial

5 1/2" x 5 1/2" x 5" 7 lbs.

✓
1957
x x

Greenacres Rd, Oldham.
Lee's Foundry dem. 15. 6. 80.

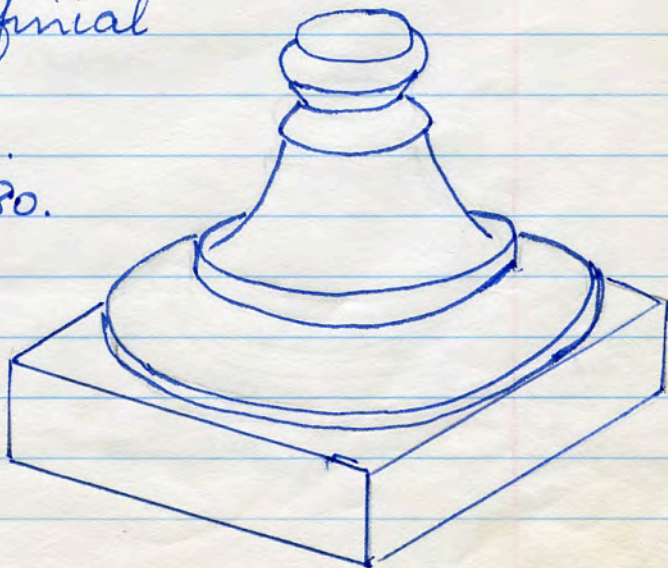

1960



1958 x

Blue wall capping.
no name, no panels.
26 lbs $11\frac{3}{4}" \times 11\frac{1}{2}" \times 4\frac{1}{2}"$
Sovereign Rd dem. Wigan.
1. 6. 80.

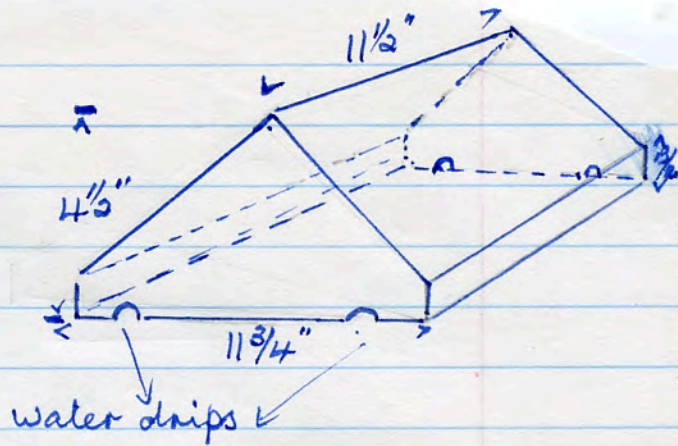

1959 x

Blue wall capping
no name, no panels
20 lbs.
Sovereign Rd dem. Wigan
1. 6. 80

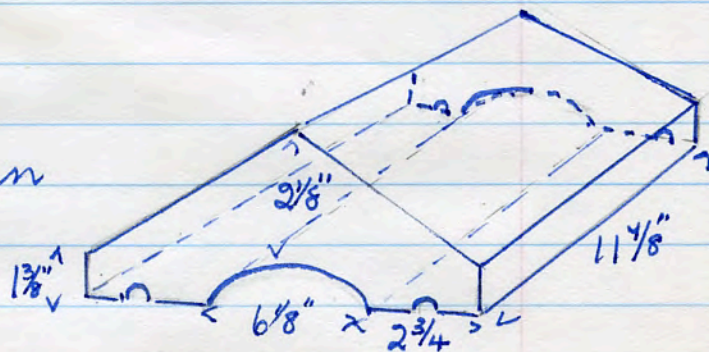

1960 x
328

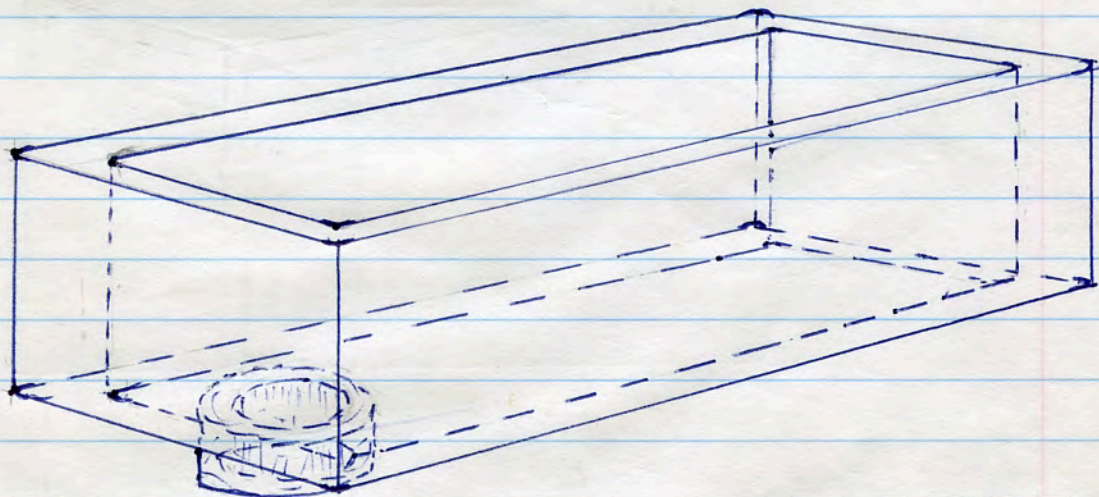

salt glazed drain dish
measures (outside) $19" \times 12" \times 6"$
" (inside) $16" \times 9" \times 4\frac{1}{4}"$
outlet projection past base $1\frac{1}{2}"$ grate diam. $7\frac{3}{8}"$
Weight 56 lbs.
Rear dem. Asa Lees Foundry - Greenacres Rd.
Oldham, 15. 6. 80.

1970 x
 No name. Red paver. $10\frac{1}{4}'' \times 5'' \times 1\frac{3}{4}''$ 7 lbs.
 single panel rev.
 Langton Warehouse dem
 L/pool Rlwy. 8. 6. 80.

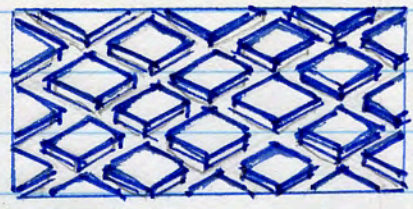

1971 x
 No name Blue paver $10'' \times 6'' \times 2''$
 No panel rev. 9 lbs Diamond design as above
 Railway hut dem. ^{Peppold Street} Seadley Waste
 22. 6. 80

1972 x
 Terna cotta wall capping 31 lbs No name.
 Guide St. dem. Waste
 22. 6. 80.

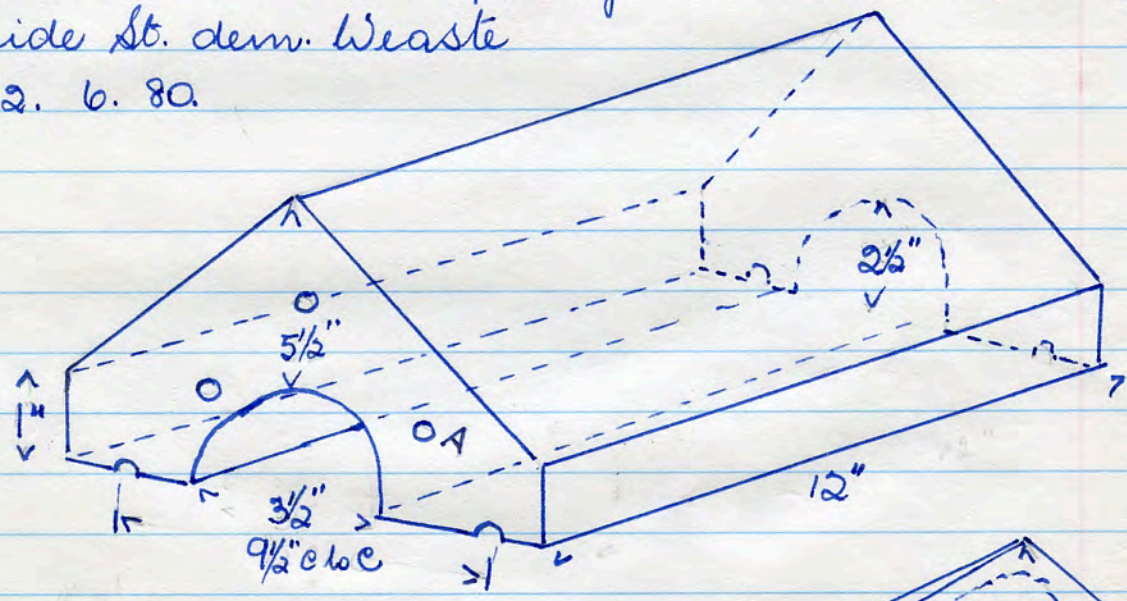

No name.
 Wall capping. salt glazed
 Ordsall. opt Palmolive
 Works. 22. 6. 80.

1973 x
 No name.
 Wall capping. salt glazed
 Ordsall. opt Palmolive
 Works. 22. 6. 80.

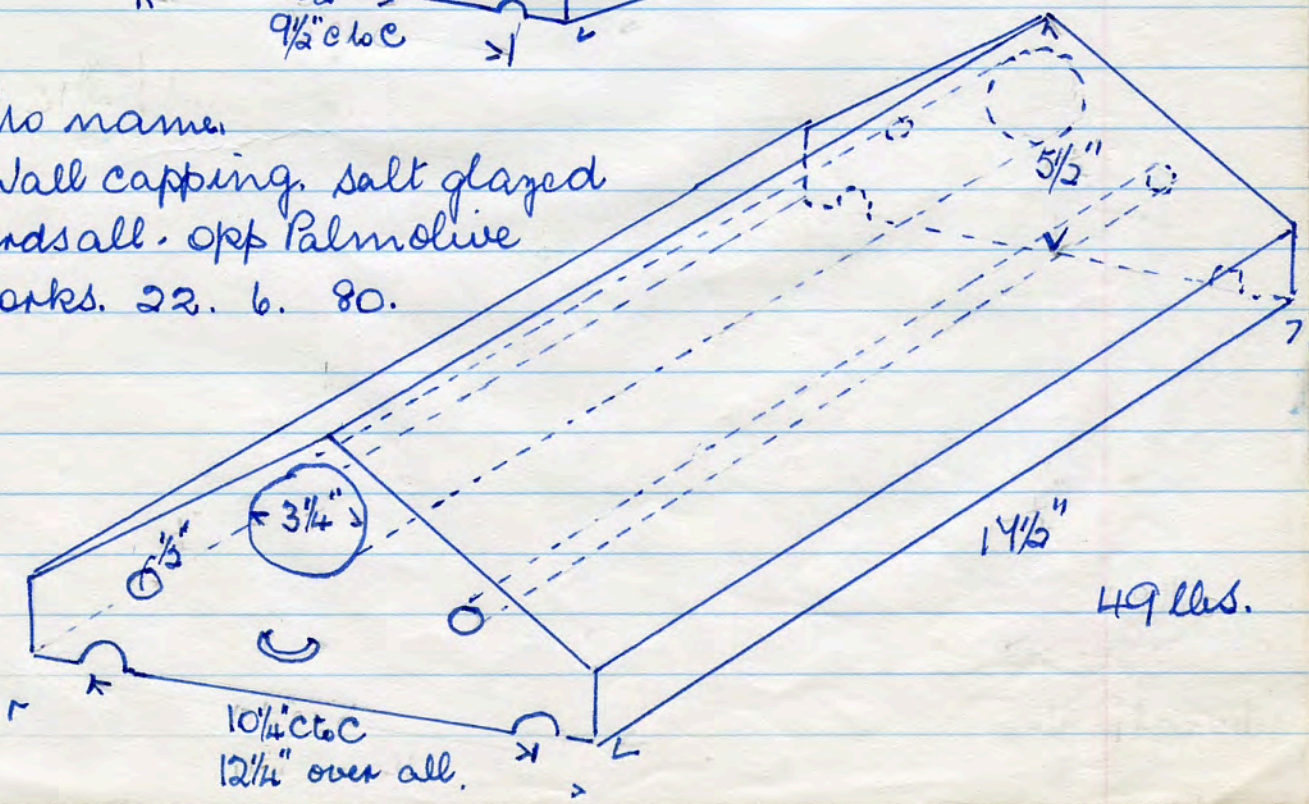

1974
x²

VITROS red garden edge tile
8³/₄" x 6³/₈" x 1" + 2" 4¹/₂ lbs.

letters incised in slightly raised
oval panel. 4 beads (tiny).
Langton Warehouse dem. L/pool
Rlwy. 8. 6. 80.

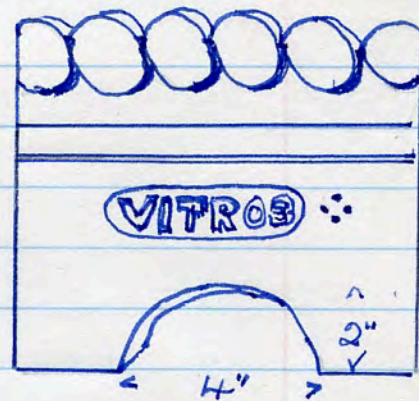

1975
x²

No name. red garden edge tile
8³/₁₆" x 8¹/₄" x 1" + 1³/₄" 7 lbs.

rope pattern
Langton Warehouse dem. L/pool
Rlwy. 8. 6. 80.

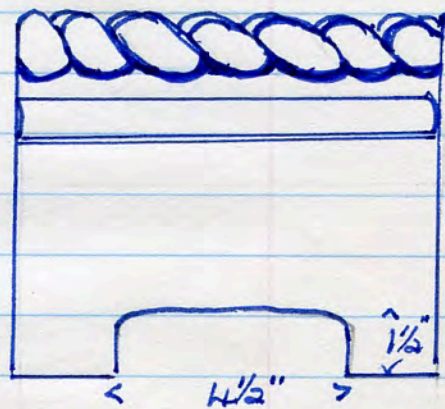

1976
x²

No name. red garden edge tile
9" x 7" x 7/8" + 1³/₄" 6 lbs.

rope pattern - opp to 1975 above.
Langton Warehouse dem. L/pool
Rlwy. 8. 6. 80.

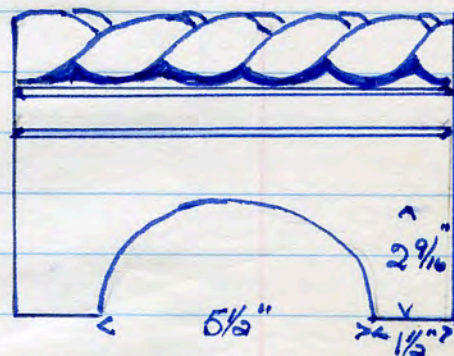

1977
x²

J C E RUABON N WALES
part floor tile, red terra cotta.
9" x 9" x 1/4" (whole). 5 lbs (part)

letters in relief on reverse.
plain obverse.
Langton Warehouse dem. 8. 6. 80.

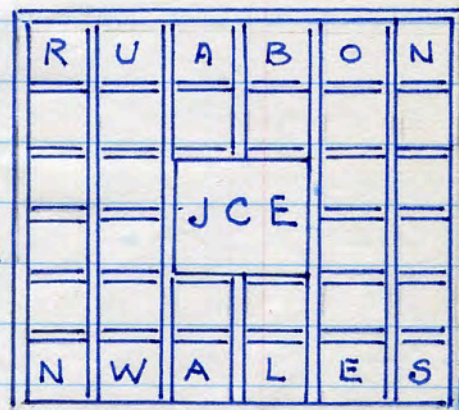

1978
x²

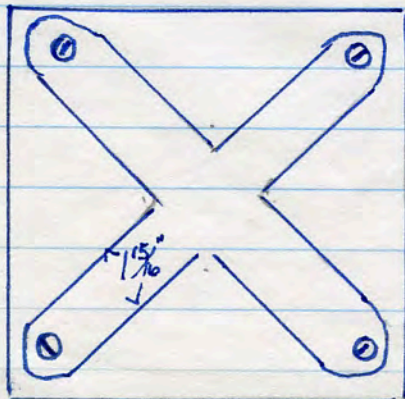

9 lbs.

No name. buff tile
8⁷/₈" x 8³/₄" x 1³/₄"
plain obverse.
Langton Warehouse
dem. 8. 6. 80

1999
x*

OP  2 red tile 5 13/16" x 5 13/16" x 13/16"
plain obverse, letters in relief in
circular shallow panel rev.
Langton Warehouse dem. L/pool
8. 6. 80.

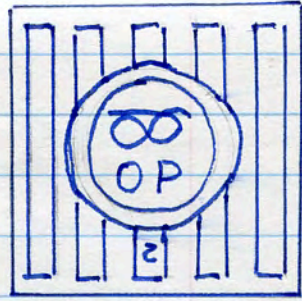

1994
x*

No name. 9 lbs. red 11 1/2" x 4 1/2" x 3"
single panel one side only
plain reverse.
Wigan Rd, Whitehill, Bryn.
289 6. 80.



1995
x*

No name. string course brick
single panel in base.
3 triangles in relief on face edge.
red. 7 lbs. 9" x 4 1/4" x 3"
Sutton Rd, St Helens. 289. 6. 80.

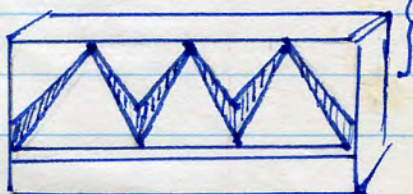
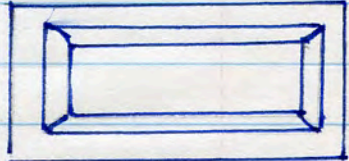

1996
x*

No name. string course brick.
9" x 4" x 3" 6 lbs. red.
4 pyramids in relief on face edge
Sutton Rd, St. Helens. 29. 6. 80

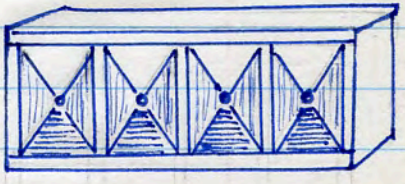

1997
x

WOOLLISCROFT ENGLAND. 469
small red floor tile 1 lb 3 ozs.
tiny letters in relief on reverse. 10 1/2" x 6" x 3" x 5/8"
Sutton Rd, St. Helens. 29. 6. 80.

